



Torque Motors – Kit version

TK Series

Technical Manual

PVD3645

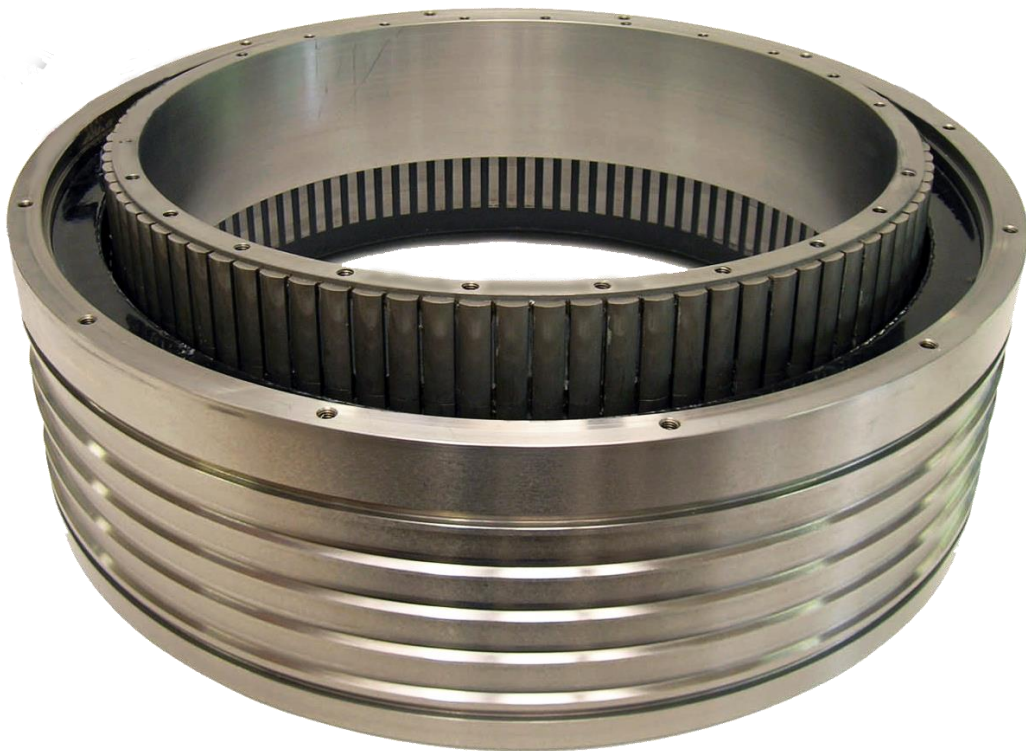



EU DECLARATION OF CONFORMITY

We ,

Parker Hannifin Manufacturing France SAS
Electromechanical & Drives Division Europe
Etablissement de Longvic
4 Boulevard Eiffel - CS40090
21604 LONGVIC Cedex - France

manufacturer, with brand name **Parker**, declare under our sole responsibility that the products

SERVOMOTORS TYPE TK

satisfy the arrangements of the directives :

Directive 2014/35/EU : “Low Voltage Directive”, LVD
Directive 2011/65/EU : “Restriction of Hazardous Substances”, RoHS
Directive 2014/30/EU : “Electromagnetic Compatibility”, EMC

and meet standards or normative document according to :

EN 60034-1:2010/AC:2010 : Rotating electrical machines - Part 1 : Rating and performance.
EN 60034-5:2001/A1:2007 : Rotating electrical machines - Part 5 : Degrees of protection provided by the integral design of rotating electrical machines (IP code) - Classification.
EN 60204-1:2006/AC:2010 : Safety of machinery – Electrical equipment of machines – Part 1 : General requirements.

The product itself is not impacted by the modifications made on the latest directives.

The undersigned certify that the above mentioned model is procured in accordance with the above directives and standards.

Further information :

SERVOMOTORS shall be mounted on a mechanical support providing good heat conduction and not exceeding 40° C in the vicinity of the motor flange.

As TK is a kit motor, final conformance of the complete motor is under the responsibility of the integrator.

The product must be installed in accordance with the instructions and recommendations contained in the operating instructions supplied with the product.

TK C.E. Marking : May 12th 2009

Longvic, November 18th 2016

In the name of Parker
A. ANDRIOT
Quality Manager

Ref : DCE-TK-001rev0



Table of Content

1. INTRODUCTION	5
1.1. Purpose and intended audience	5
1.2. Safety	5
1.2.1. Principle	5
1.2.2. General Safety Rules	6
2. PRODUCT DESCRIPTION	7
2.1. Quick URL	7
2.2. Overview	7
2.3. Motor description	8
2.4. General Technical Data	9
2.5. Product Code	10
3. TECHNICAL DATAS	11
3.1. Motor selection	11
3.1.1. Altitude derating	11
3.1.2. Temperature derating	11
3.1.3. Thermal equivalent torque (rms torque)	14
3.1.4. Drive selection	16
3.1.5. Current limitation at stall conditions (i.e. speed < 3 rpm)	20
3.1.6. Peak current limitations	20
3.2. TK Characteristics: Torque, speed, current, power	21
3.2.1. TKA - Natural cooling - Mains voltage 3 AC 400 V	22
3.2.2. TKW - Water cooling - Mains voltage 3 AC 400 V	23
3.2.3. Further Data with natural cooling	25
3.2.4. Further Data with water cooling	26
3.2.5. Efficiency curves	28
3.2.6. Electromagnetic losses	58
3.2.7. Time constants of the motor	59
3.2.8. Speed ripple	61
3.2.9. Rated data according to rated voltage variation	61
3.2.10. Voltage withstand characteristics of TK series	63
3.3. Dimension drawings	64
3.3.1. TKA130 standard configuration	64
3.3.2. TKA200 standard configuration	65
3.3.3. TKA300 standard configuration	66
3.3.4. TKA400 standard configuration	67
3.3.5. TKW130 standard configuration	68
3.3.6. TKW200 standard configuration	69
3.3.7. TKW300 standard configuration	70
3.3.8. TKW400 standard configuration	71
3.4. Motor mounting recommendations	72
3.4.1. Frame recommendation	72
3.4.2. Mechanical interfaces	73
3.4.3. Water inlet / outlet position	75
3.4.4. O ring specification	76
3.4.5. Condensation water drain hole	76
3.4.6. Design Compliance	77
3.4.7. Dielectric test	77
3.4.8. Earthing	77
3.4.9. Minimum clearances for insulation and creepage distances	77
3.4.10. Ground continuity compliance	78
3.4.11. Protection rating	78
3.4.12. Overspeed test	79
3.4.13. EMC Directive	79
3.4.14. Other requirements	79
3.5. Cooling	80
3.5.1. Natural cooled motor – TKA series	80
3.5.2. Water cooled motor – TKW series	81
3.5.3. Additives for water as cooling media	82
3.5.4. Motor cooling circuit drop pressure	83
3.5.5. Chiller selection	84
3.5.6. Parker Hiross Chiller selection vs TMW series	85



3.5.7.	Flow derating according to glycol concentration	86
3.5.8.	Water cooling diagram.....	88
3.5.9.	Condensation water drain hole.....	90
3.6.	Thermal Protection	91
3.6.1.	Alarm tripping with PTC thermistors :.....	91
3.6.2.	Temperature measurement with KTY sensors:.....	92
3.7.	Power Electrical Connections	93
3.7.1.	Wires sizes	93
3.7.2.	Conversion Awg/kcmil/mm ² :.....	94
3.7.3.	Motor cable length	95
3.7.4.	Ground connection	95
3.7.5.	Motor cable.....	95
4.	COMMISSIONING AND USE.....	97
4.1.	Instructions for commissioning and use	97
4.1.1.	Equipment delivery	97
4.1.2.	Handling	97
4.1.3.	Storage	97
4.2.	Machine Integration.....	98
4.2.1.	General warnings	98
4.2.2.	Tightening torque.....	99
4.2.3.	Magnetic attraction forces	100
4.2.4.	Integration step by step	101
4.3.	Electrical connections	106
4.4.	Encoder cable handling.....	108
4.5.	Tests.....	109
4.6.	Troubleshooting	110

1. INTRODUCTION

1.1. Purpose and intended audience

This manual contains information that must be observed to select, install, operate and maintain PARKER TK Torque Motors in kit.

The design, tests, certification, commissioning, operation and maintenance of the equipment should be carried out by qualified personnel. A qualified person is someone who is technically competent and familiar with all safety information and established safety practices; with the installation process, operation and maintenance of this equipment; and with all the hazards involved.

Reading and understanding the information described in this document is mandatory before carrying out any operation on the motors. If any malfunction or technical problem occurs, that has not been dealt with in this manual, please contact PARKER for technical assistance. In case of missing information or doubts regarding the installation procedures, safety instructions or any other issue tackled in this manual, please contact PARKER as well.

PARKER's responsibility is limited to its torque motors and does not encompass the whole user's system. Data provided in this manual are for product description only and may not be guaranteed, unless expressly mentioned in a contract.



DANGER: PARKER declines responsibility for any accident or material damage that may arise, if the procedures and safety instructions described in this manual are not scrupulously followed.

1.2. Safety





1.2.1. Principle

To operate safely, this equipment must be transported, stored, handled, installed and serviced correctly. Following the safety instructions described in each section of this document is mandatory. Torque Motors usage must also comply with all applicable standards, national directives and factory instructions in force.



DANGER: Non-compliance with safety instructions, legal and technical regulations in force may lead to physical injuries or death, as well as damages to the property and the environment.

1.2.2. General Safety Rules

	<p>Generality DANGER: The installation, commission and operation must be performed by qualified personnel, in conjunction with this documentation.</p> <p>The qualified personnel must know the safety (C18510 authorization, standard VDE 0105 or IEC 0364) and local regulations.</p> <p>They must be authorized to install, commission and operate in accordance with established practices and standards.</p>
	<p>Electrical hazard</p> <p>Servo drives may contain non-insulated live AC or DC components. Respect the drives commissioning manual. Users are advised to guard against access to live parts before installing the equipment.</p> <p>Some parts of the motor or installation elements can be subjected to dangerous voltages, when the motor is driven by the inverter , when the motor rotor is manually rotated, when the motor is driven by its load, when the motor is at standstill or stopped.</p> <p>For measurements use only a meter to IEC 61010 (CAT III or higher). Always begin using the highest range. CAT I and CAT II meters must not be used on this product.</p> <p>Allow at least 5 minutes for the drive's capacitors to discharge to safe voltage levels (<50V). Use the specified meter capable of measuring up to 1000V dc & ac rms to confirm that less than 50V is present between all power terminals and between power terminals and earth.</p> <p>Check the drive recommendations. The motor must be permanently connected to an appropriate safety earth. To prevent any accidental contact with live components, it is necessary to check that cables are not damaged, stripped or not in contact with a rotating part of the machine. The work place must be clean, dry.</p> <p>General recommendations :</p> <ul style="list-style-type: none"> - Check the wiring circuit - Lock the electrical cabinets - Use standardized equipment
	<p>Mechanical hazard</p> <p>Servomotors can accelerate in milliseconds. Running the motor can lead to other sections of the machine moving dangerously. Moving parts must be screened off to prevent operators coming into contact with them. The working procedure must allow the operator to keep well clear of the danger area.</p>
	<p>Burning Hazard</p> <p>Always bear in mind that some parts of the surface of the motor can reach temperatures exceeding 100°C.</p>

2. PRODUCT DESCRIPTION

2.1. Quick URL

All informations and datas are available on :

<http://www.parker.com/eme/tk>

2.2. Overview

The TK frameless servomotor are the active parts of a servo motor: a rotor and a stator. The TK series can not be used alone and must integrated into a complete system to provide a complete torque motor. The design, the construction, the certification and the tests are the responsibility of the integrator.

TK Torque Motors Series in kit version from PARKER are innovative direct drive solutions designed for industrial applications requiring high torque at low speed.

TK Torque Motors from PARKER are permanent magnet based servomotors with a high number of poles, able to deliver torques up to 22,000Nm at speeds ranging up to 2,500 rpm. Based on brushless technology, they offer the following decisive advantages:

- high torque densities for a maximum **compactness, accuracy, dynamics and repeatability**
- **high efficiencies** because there are no transmission elements (gear or belt)
- there are few machine's mechanical parts, they are **simple, robust, light** and with a **lower cost**
- direct drive solution is with **no maintenance and high reliability**.

TK Torque Motors deliver their full performance in association with the AC890 Parker Drives family. These drives run induction motors, torque motors and permanent magnets servo motors in control modes from simple Volts/Hz to precision closed loop vector with positioning.

2.3. Motor description

PARKER Torque Motors have been especially designed to replace traditional motor + gearbox sets or traditional motor + timing belt on **machine tool table, winders, crushers, mixers**, and more generally in all application segments requiring **kit** torque motors with a power up to 400kW.

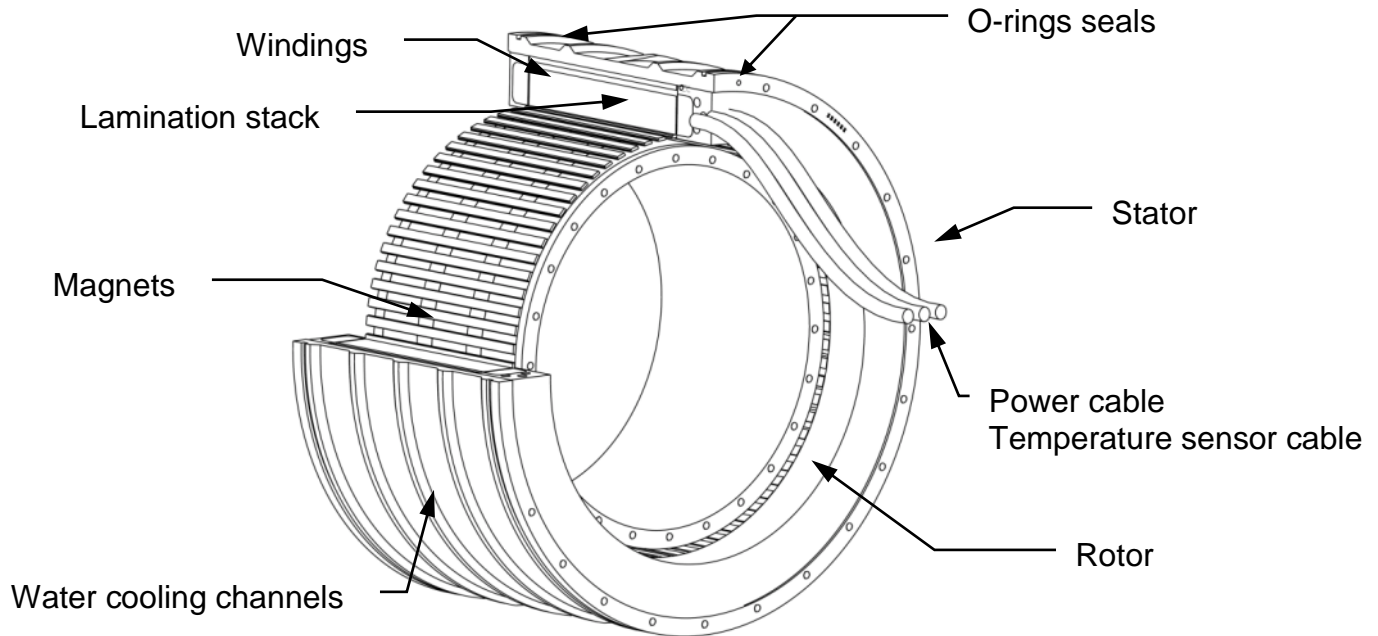

2.4. General Technical Data

Motor type	Permanent-magnet synchronous motor															
Magnet material	Nd-Fe-B (Neodymium Iron Boron)															
Number of poles	<table border="1"> <tr> <td>Size:</td> <td>TK_130</td> <td>TK_200</td> <td>TK_300</td> <td>TK_400</td> </tr> <tr> <td>Polarity:</td> <td>High</td> <td>High</td> <td>High</td> <td>High</td> </tr> <tr> <td>Nbr of poles:</td> <td>30</td> <td>60</td> <td>90</td> <td>120</td> </tr> </table>	Size:	TK_130	TK_200	TK_300	TK_400	Polarity:	High	High	High	High	Nbr of poles:	30	60	90	120
Size:	TK_130	TK_200	TK_300	TK_400												
Polarity:	High	High	High	High												
Nbr of poles:	30	60	90	120												
Shaft heights	130 mm 200 mm 315 mm 400 mm															
Degree of protection	IP00															
Cooling	Water or natural cooling															
Cooling water temperature	5°C to 25°C (IEC 60034-1) – to avoid condensation see §3.5															
Altitude	Up to 1000m (IEC 60034-1) (for higher altitude see §3.1.1 for derating)															
Rated voltage	400 VAC and 480 VAC															
Connections	Power cables, PTC and KTY sensors cable															
Insulation of the stator winding	Class F according to EN 60034-1 with potting															
Thermal protection	2 PTC probes and 1 KTY sensor															
Operating temperature	-15°C to +40°C for natural cooling version (IEC 60034-1) 0°C to 40°C for water cooled version (IEC 60034-1) – to avoid condensation see §3.5															
Storage temperature	-20... +60°C															



2.5. Product Code

Code	T	K	W	2	0	4	H	P	K	C	B	2	R	1	0	0	0
Product Series	_____																
Cooling Method	_____																
W = Water cooling A = Natural air cooling																	
Shaft Height	_____																
13 = 130 mm 20 = 200 mm 30 = 315 mm 40 = 400 mm																	
Torque / Speed Characteristics	_____																
See motor data.																	
Feedback Sensor	_____																
K = without sensor B = Endat encoder ECN113																	
Mounting device	_____																
B = Bridge on both side C = Bridge on cable inlet D = Bridge opposite on cable inlet Z = Without bridge																	
Wires inlet	_____																
B2 = 2 meters on the back																	
Unused character	_____																
Electric connection	_____																
1 = 3 wires inlet (3 phases)																	
Thermal protection	_____																
0 = 1 PTC 140°C + 1 PTC 150°C + 1 KTY (+1KTY in reserve)																	
Mechanical Interface	_____																
00 = Standard motor																	

3. TECHNICAL DATAS

3.1. Motor selection

3.1.1. Altitude derating

From 0 to 1000 m : no derating

From 1000 to 4000 m : torque derating of 5% for each step of 1000 m for TKW

From 1000 to 4000 m : torque derating of 10% for each step of 1000 m for TKA

3.1.2. Temperature derating

3.1.2.1. Natural cooled motor

The maximal temperature for natural cooling is 40°C. But, it is possible to increase a little bit the ambient temperature above 40°C, with a torque reduction. The following formula gives an indicative about the torque derating at low speed. But in any case refer to PARKER technical department to know the exact values

At low speed the torque derating is given by the following formula for an ambient temperature > 40°C.

$$\text{Torque_derating}[\%] = 100 * \sqrt{\frac{(145^{\circ}\text{C} - \text{Ambient_temperature}^{\circ}\text{C})}{105^{\circ}\text{C}}}$$

	<p>At high speed, the calculation is more complex, and the derating is much more important. Please refer to PARKER to know the precise data of Torque derating according to ambient temperature at high speed for a specific motor.</p>
--	---

Illustration: Only for example given for the TKA208H

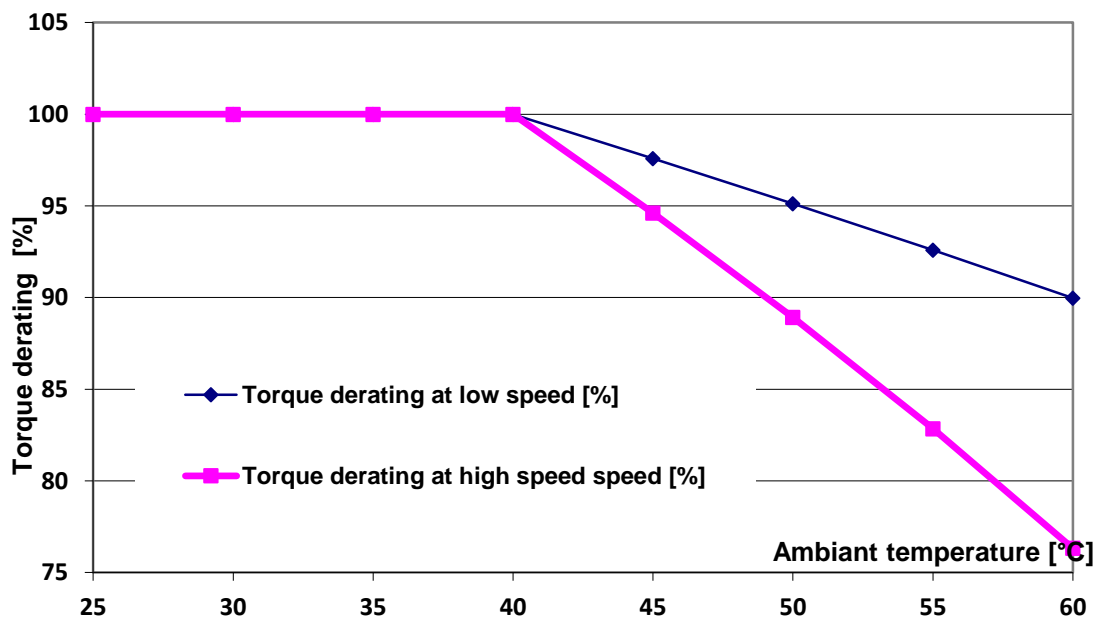

3.1.2.2. Water cooled motor

Typical values are given with a water inlet temperature of 25°C and a temperature gradient Inlet-Outlet of 10°C. These references lead to a winding overheating of 95°C corresponding to a winding temperature of 120°C. Recommendations regarding condensation issues are given at § 3.5

It is possible to increase a little bit the Inlet temperature up to 45°C, but the torque must be reduced. The following curves give an indicative of the derating versus the speed for different temperature.

Derating curve vs speed for TKW13x at nominal water flow (50%glycol)

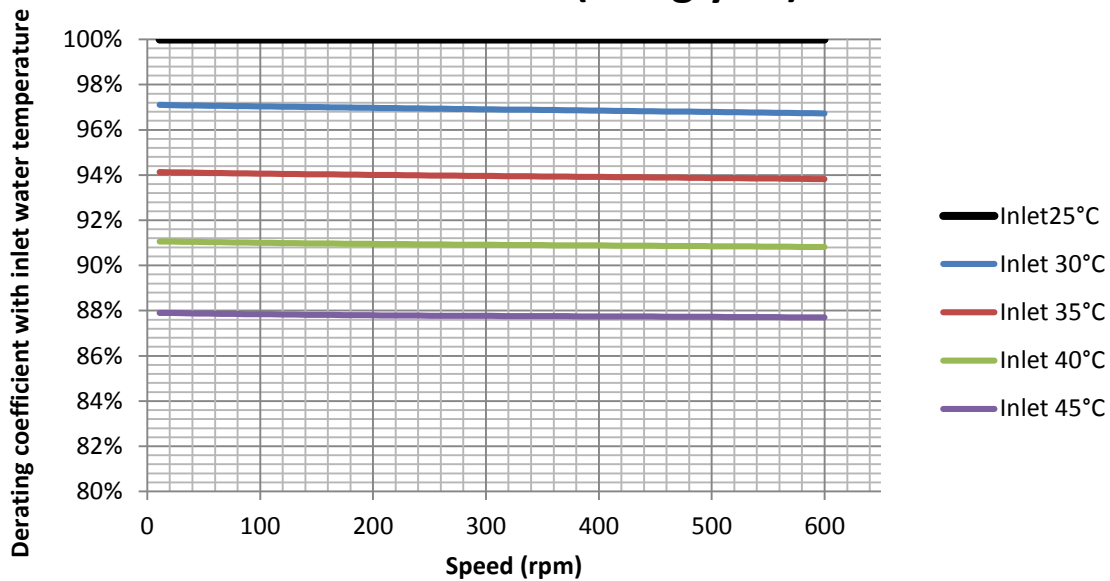

Derating curve vs speed for TKW2xx at nominal water flow (50% glycol)

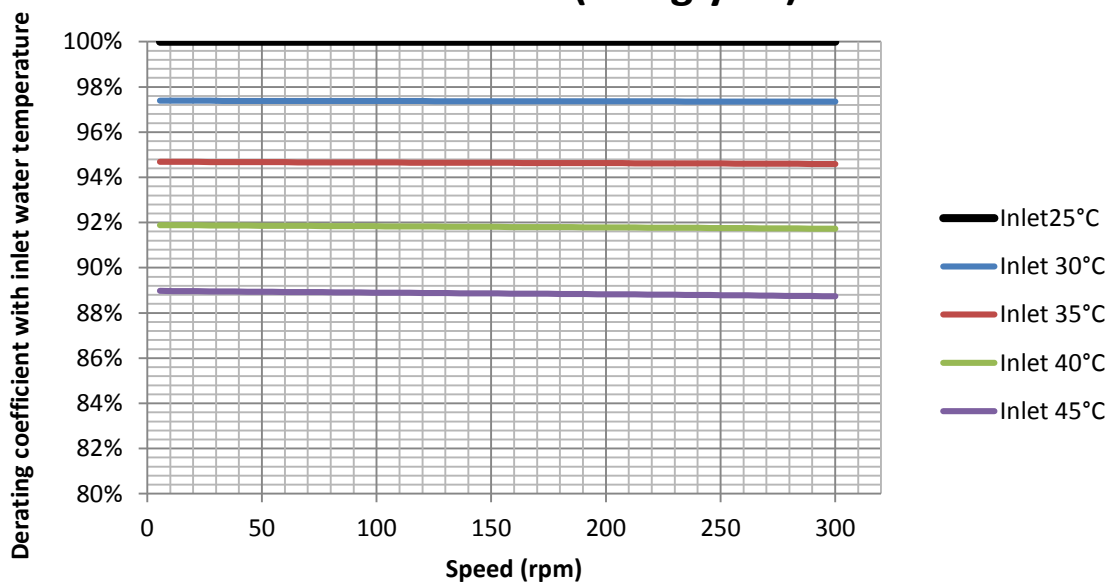

Derating curve vs speed for TKW3xx at nominal water flow (50%glycol)

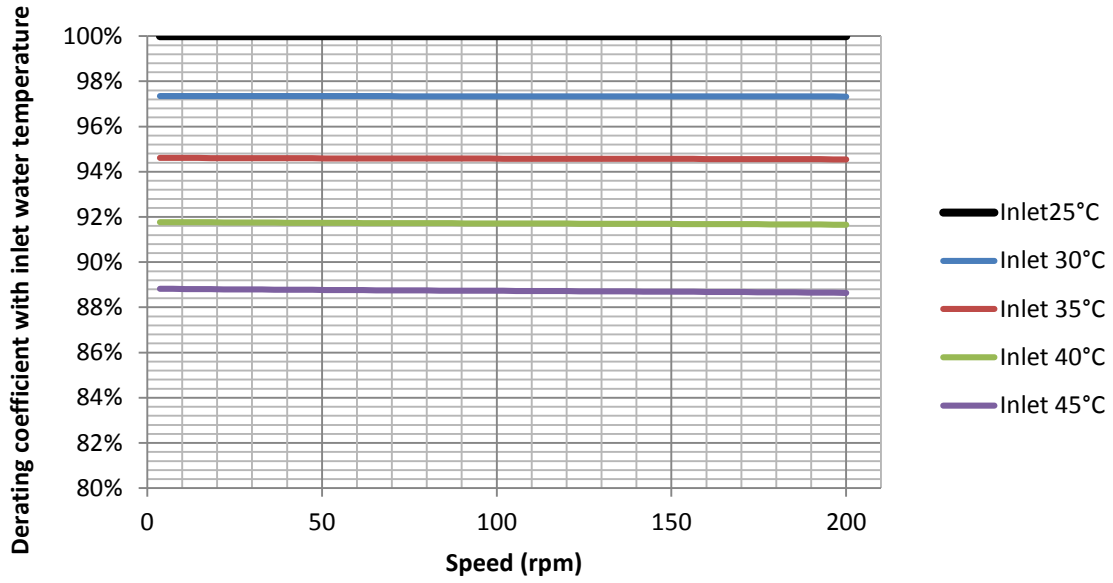

Derating curve vs speed for TKW4xx at nominal water flow (50%glycol)

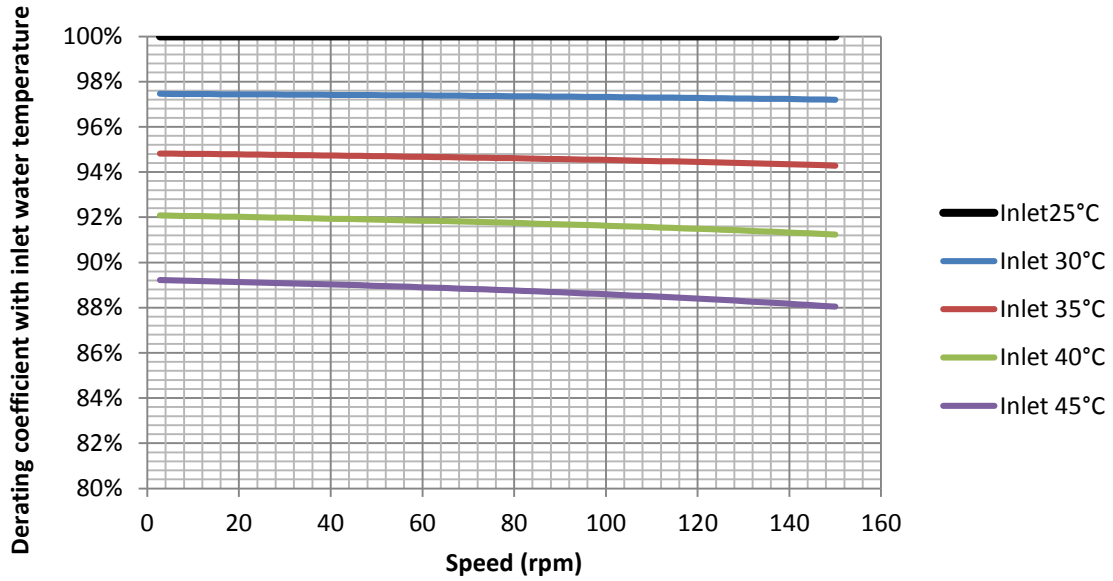

3.1.3. Thermal equivalent torque (rms torque)

The selection of the right motor can be made through the calculation of the rms torque M_{rms} (i.e. root mean squared torque) (sometimes called equivalent torque).

This calculation does not take into account the thermal time constant. It can be used only if the overload time is much shorter than the copper thermal time constant.

The rms torque M_{rms} reflects the heating of the motor during its duty cycle.

Let us consider:

- the period of the cycle T [s],
- the successively samples of movements i characterized each ones by the maximal torque M_i [Nm] reached during the duration Δt_i [s].

So, the rms torque M_{rms} can be calculated through the following basic formula:

$$M_{rms} = \sqrt{\frac{1}{T} * \sum_{i=1}^n M_i^2 \Delta t_i}$$

Example:

For a cycle of 2s at 0 Nm and 2s at 100Nm, the rms torque is

$$M_{rms} = \sqrt{\frac{1}{4} * 100^2 * 2} = 70,7Nm$$

Illustration :

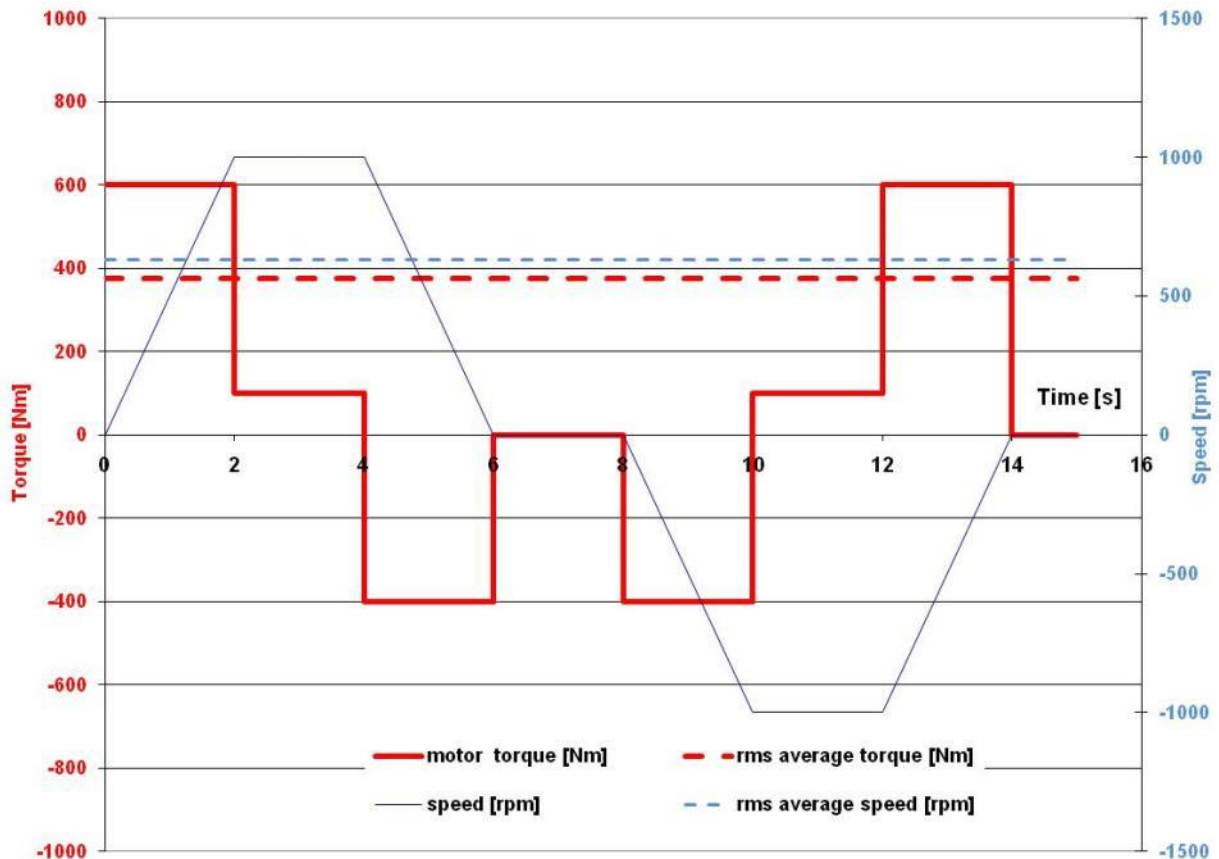

The maximal torque M_i delivered by the motor at each segment i of movement is obtained by the algebraic sum of the acceleration-deceleration torque and the resistant torque.

Therefore, M_{max} corresponds to the maximal value of M_i .

Selection of the motor :

The motor adapted to the duty cycle has to provide the rms torque M_{rms} at the rms speed(*) without extra heating. This means that the permanent torque M_n available at the average speed presents a sufficient margin regarding the rms torque M_{rms} .

$$\Omega_{rms} = \sqrt{\frac{1}{T} * \sum_{i=1}^n \Omega_i^2 \Delta t_i}$$

(*) rms speed is calculated thanks to the same formula as that used for the rms torque. The mean speed cannot be used (in general mean speed is equal to zero). Only use the rms speed

Furthermore, each M_i and speed associated Ω_i of the duty cycle has to be located in the operational area of the torque vs speed curve

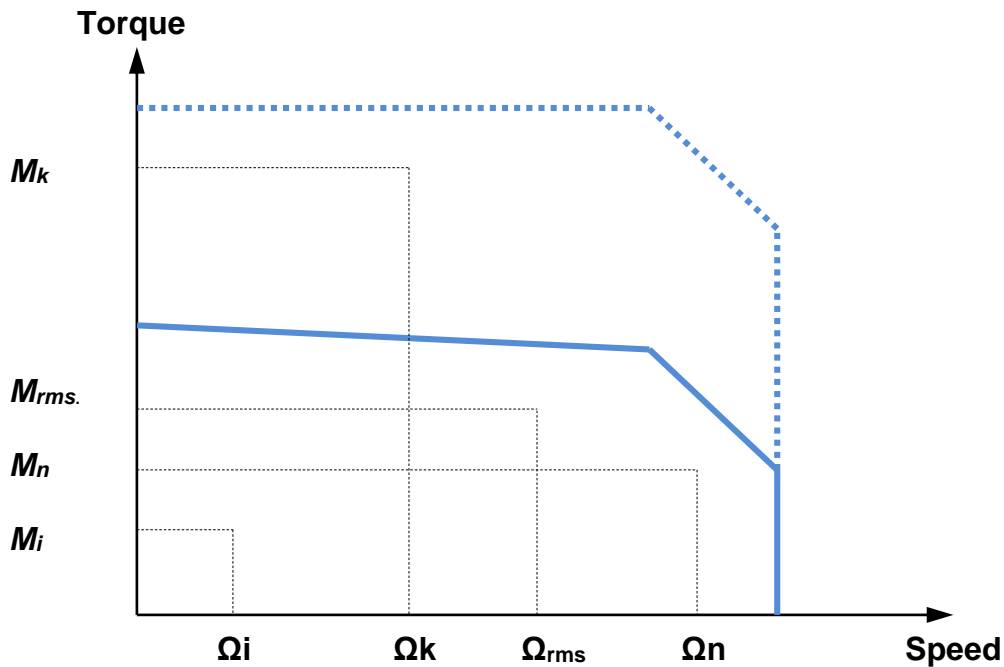

3.1.4. Drive selection

Drive selection depends on its rated power and its mode selection which leads to the maximal current duration.

	<p>Please refer to the drive technical documentation for any further information and to select the best motor and drive association.</p>
---	--

AC890 Parker drive example:

The rated current provided by the AC890 PARKER drive depends on its rated power and its mode selection. Vectorial mode or Servo mode for a power < 37 kW, Constant torque or Quadratic torque for a power > 37 kW.

Once the mode selection set, the rated current corresponds to 100%.

(The rated current with the Quadratic mode selection is greater than with the Constant torque mode selection.)

Power of Drive AC890 [kW]	<37 kW		>37 kW		
Mode	vectoriel mode	servo mode	constant torque		quadratic torque
Overload capability [%]	150% during 60 s	200% during 4 s	150% during 60 s	180% during 0.5 s	110% during 60 s

Illustration:

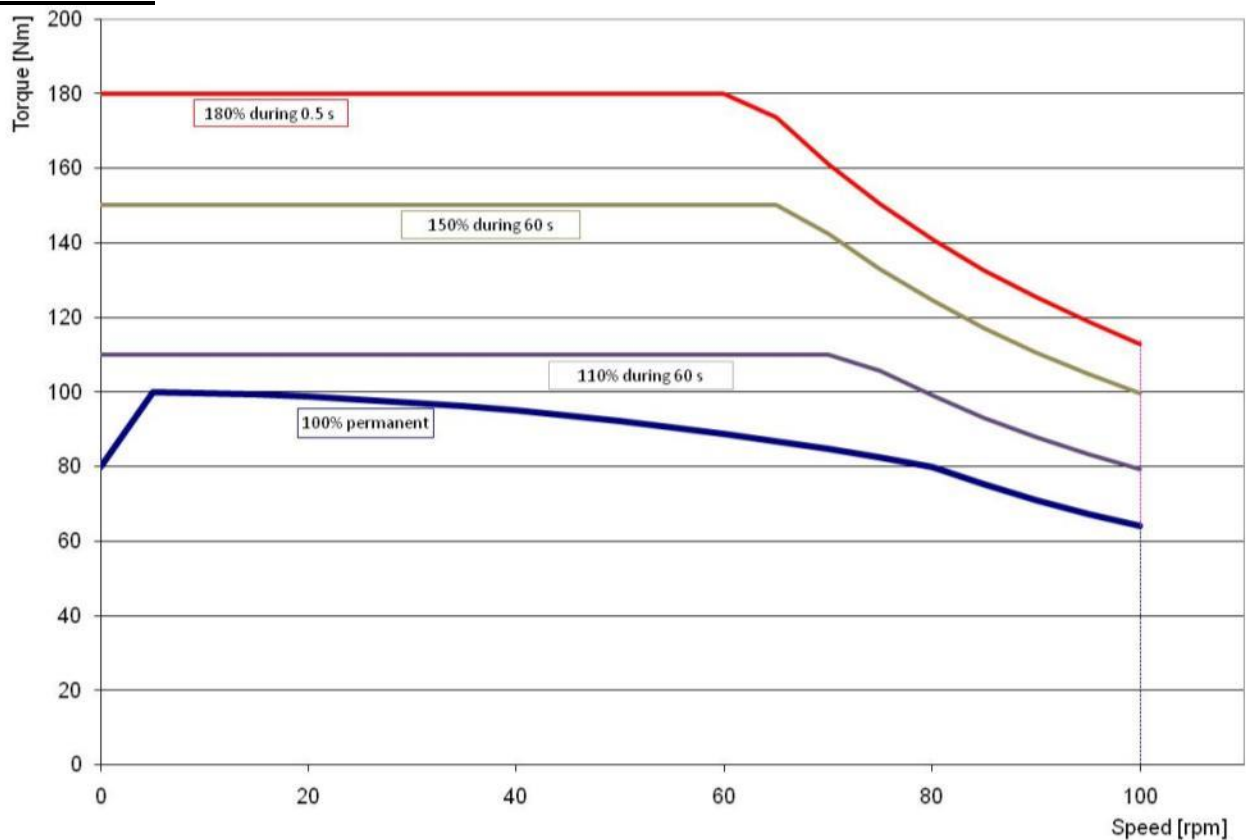



Example n°1 :

The application needs:

- A rms torque of **4000 Nm** at the rms speed of **100 rpm**,
- An acceleration torque of **7000 Nm**,
- A maximal speed of **140 rpm**.

Selection of the motor:

The selected motor is the type **TKW306HM**.

The nominal speed is equals to 105 rpm.

The maximal speed is equals to 150 rpm.

The torque sensitivity is equals to 40.5 Nm/Arms.

BRUSHLESS MOTOR TKW306HM ELECTRONIC DRIVE AC890SD43 3156F-135Arms(constant)	
--	--

Ph	Rated power	53.9	kW	Cooling : water cooling Cooling : IC 97 W Minimum flow : 21 l / min Maximum temperature : 25 °C Maximum pressure : 5 bars
Mn	Rated torque	4900	Nm	
Nn	Rated speed	105	rpm	
In	Rated current	122	A _{rms}	
Un	Rated voltage	357	V _{rms}	
UR	Voltage of the mains	400	V _{rms}	Ambient temperature : 40°C max Altitude : < 1.000 m Thermal class : F (according to CEI 34-1) Number of poles : 90
U	DC voltage supply when motor is loaded	540	V	
M _s	Low speed torque	4950	Nm	
I ₀	Permanent current at low speed	122	A _{rms}	
M _p	Max. torque	7110	Nm	
I _p	Max. current	183	A _{rms}	Efficiency : at rated torque ** : 80.1 % at 75 % of the rated torque ** : 85.7 %
N _p	Max. speed	150	rpm	
J	Rotor inertia	3.4	kg.m ²	
Ke	Back emf constant at 1000 rpm (25°C)*	2550	V _{rms}	
Kt	Torque sensitivity	40.5	Nm/A _{rms}	
Rb	Winding resistance(25°C) *	0.424	Ω	
L	Winding inductance *	3.93	mH	

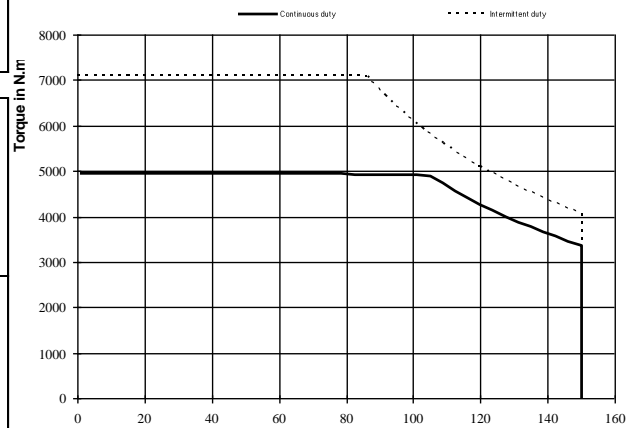

The permanent current **I₀** of the motor is **122 Arms** for **4950 Nm** at low speed.

The nominal current **I_n** of the motor is **122 Arms** for **4900 Nm** at the nominal speed.

Selection of the drive:

The drive has to provide at least a permanent current equal to **I₀** (122 Arms).

In order to obtain an acceleration torque of **7000 Nm**, the current will be about 180 Arms

(the motor data sheet shows 7110 Nm with 183 Arms). This means that the drive has to provide at least 180 Arms as transient current.

→ Therefore, we can select the drive **AC890 PARKER SD-43 3156 F** which delivers under 400 VAC:

135 Arms as permanent current and

135*150%=202 Arms as maximal transient current during 60 s.

Under these conditions, the drive runs with “**Constant as Servo Mode**”.

Example n°2 :

This times, the application needs:

- A rms torque of **4000 Nm** at the rms speed of **100 rpm**,
- An acceleration torque of **6000 Nm**,
- A maximal speed of **140 rpm**.

Selection of the motor:

The selected motor is the type **TKW306HM**.

The nominal speed is equals to 104 rpm.

The maximal speed is equals to 150 rpm.

The torque sensitivity is equals to 40.5 Nm/Arms.

BRUSHLESS MOTOR TKW306HM ELECTRONIC DRIVE AC890SD43 3145F-143Arms(quadratic)	
---	--

Pn	Rated power	53.2	kW	Cooling : water cooling Cooling : IC 97 W Minimum flow : 23 l / min Maximum temperature : 25 °C Maximum pressure : 5 bars Ambient temperature : 40°C max Altitude : < 1.000 m Thermal class : F (according to CEI 34-1) Number of poles : 90 Efficiency : at rated torque ** : 79.9 % at 75 % of the rated torque ** : 85.5 %
Mn	Rated torque	4900	Nm	
Nn	Rated speed	104	rpm	
In	Rated current	122	A _{rms}	
Un	Rated voltage	353	V _{rms}	
UR	Voltage of the mains	400	V _{rms}	
U	DC voltage supply when motor is loaded	540	V	
M ₀	Low speed torque	4950	Nm	
I ₀	Permanent current at low speed	122	A _{rms}	
M _p	Max. torque	6210	Nm	
I _p	Max. current	157	A _{rms}	
N _p	Max. speed	150	rpm	
J	Rotor inertia	3.4	kg.m ²	
K _e	Back emf constant at 1000 rpm (25°C)*	2550	V _{rms}	
K _t	Torque sensitivity	40.5	Nm/Arms	
R _b	Winding resistance(25°C) *	0.424	Ω	
L	Winding inductance *	3.93	mH	

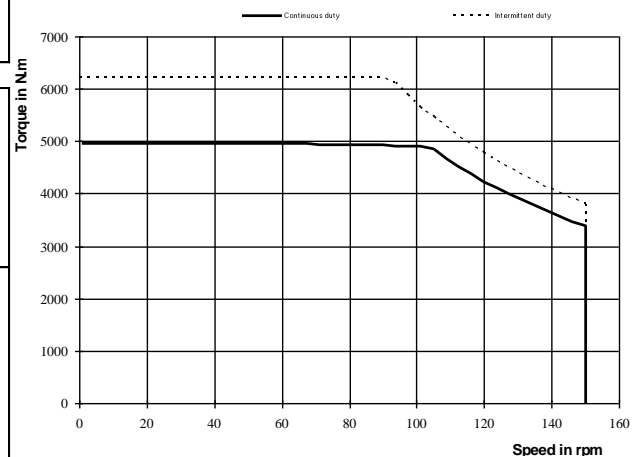

The permanent current **I₀** of the motor is **122 Arms** for **4950 Nm** at low speed.

The nominal current **I_n** of the motor is **122 Arms** for **4900 Nm** at the nominal speed.

Selection of the drive:

The drive has to provide at least a permanent current equals to **I₀** (122 Arms).

In order to obtain an acceleration torque of **6000 Nm**, the current will be of about 150 Arms

(the motor data sheet shows 6210 Nm with 157 Arms). This means that the drive has to provide at least 150 Arms as transient current.

→ Therefore, we can select the drive **AC890 PARKER SD-43 3145 F** which delivers under 400 VAC:

143 Arms as permanent current and

143*110%=157 Arms as maximal transient current during 60 s.

Under these conditions, the drive runs with “**Quadratic as Servo Mode**”.

The maximal transient torque will be equal to 6210 Nm during 60 s.



Example n°3 :

This times, the application needs :

- a rms torque of **4500 Nm** at the rms speed of **100 rpm**,
- an acceleration torque of **5500 Nm**,
- a maximal speed of **120 rpm**.

Selection of the motor:

The selected motor is the type **TMW306LR**.
 The nominal speed is equals to 104 rpm.
 The maximal speed is equals to 150 rpm.
 The torque sensitivity is equal to 40.5 Nm/Arms.

BRUSHLESS MOTOR TKW306HM ELECTRONIC DRIVE AC890SD43 3105F-126Arms(quadratic)	
---	--

<table border="1" style="width: 100%; border-collapse: collapse;"> <tr><td>Pn</td><td>Rated power</td><td>53.2</td><td>kW</td></tr> <tr><td>Mn</td><td>Rated torque</td><td>4900</td><td>Nm</td></tr> <tr><td>Nn</td><td>Rated speed</td><td>104</td><td>rpm</td></tr> <tr><td>In</td><td>Rated current</td><td>122</td><td>A_{rms}</td></tr> <tr><td>Un</td><td>Rated voltage</td><td>353</td><td>V_{rms}</td></tr> <tr><td>UR</td><td>Voltage of the mains</td><td>400</td><td>V_{rms}</td></tr> <tr><td>U</td><td>DC voltage supply when motor is loaded</td><td>540</td><td>V</td></tr> </table>	Pn	Rated power	53.2	kW	Mn	Rated torque	4900	Nm	Nn	Rated speed	104	rpm	In	Rated current	122	A _{rms}	Un	Rated voltage	353	V _{rms}	UR	Voltage of the mains	400	V _{rms}	U	DC voltage supply when motor is loaded	540	V	<p>Cooling : water cooling Cooling : IC 97 W Minimum flow : 23 l/min Maximum temperature : 25 °C Maximum pressure : 5 bars</p>	<table border="1" style="width: 100%; border-collapse: collapse;"> <tr><td>M₀</td><td>Low speed torque</td><td>4950</td><td>Nm</td></tr> <tr><td>I₀</td><td>Permanent current at low speed</td><td>122</td><td>A_{rms}</td></tr> <tr><td>M_p</td><td>Max. torque</td><td>5540</td><td>Nm</td></tr> <tr><td>I_p</td><td>Max. current</td><td>138</td><td>A_{rms}</td></tr> <tr><td>N_p</td><td>Max. speed</td><td>150</td><td>rpm</td></tr> </table>	M ₀	Low speed torque	4950	Nm	I ₀	Permanent current at low speed	122	A _{rms}	M _p	Max. torque	5540	Nm	I _p	Max. current	138	A _{rms}	N _p	Max. speed	150	rpm
Pn	Rated power	53.2	kW																																															
Mn	Rated torque	4900	Nm																																															
Nn	Rated speed	104	rpm																																															
In	Rated current	122	A _{rms}																																															
Un	Rated voltage	353	V _{rms}																																															
UR	Voltage of the mains	400	V _{rms}																																															
U	DC voltage supply when motor is loaded	540	V																																															
M ₀	Low speed torque	4950	Nm																																															
I ₀	Permanent current at low speed	122	A _{rms}																																															
M _p	Max. torque	5540	Nm																																															
I _p	Max. current	138	A _{rms}																																															
N _p	Max. speed	150	rpm																																															
<table border="1" style="width: 100%; border-collapse: collapse;"> <tr><td>J</td><td>Rotor inertia</td><td>3.4</td><td>kg.m²</td></tr> <tr><td>Ke</td><td>Back emf constant at 1000 rpm (25°C)*</td><td>2550</td><td>V_{rms}</td></tr> <tr><td>Kt</td><td>Torque sensitivity</td><td>40.5</td><td>Nm/A_{rms}</td></tr> <tr><td>Rb</td><td>Winding resistance(25°C) *</td><td>0.424</td><td>Ω</td></tr> <tr><td>L</td><td>Winding inductance *</td><td>3.93</td><td>mH</td></tr> </table>	J	Rotor inertia	3.4	kg.m ²	Ke	Back emf constant at 1000 rpm (25°C)*	2550	V _{rms}	Kt	Torque sensitivity	40.5	Nm/A _{rms}	Rb	Winding resistance(25°C) *	0.424	Ω	L	Winding inductance *	3.93	mH	<p>Ambient temperature : 40°C max Altitude : < 1.000 m Thermal class : F (according to CEI 34-1) Number of poles : 90</p> <p>Efficiency : at rated torque ** : 79.9 % at 75 % of the rated torque ** : 85.5 %</p>																													
J	Rotor inertia	3.4	kg.m ²																																															
Ke	Back emf constant at 1000 rpm (25°C)*	2550	V _{rms}																																															
Kt	Torque sensitivity	40.5	Nm/A _{rms}																																															
Rb	Winding resistance(25°C) *	0.424	Ω																																															
L	Winding inductance *	3.93	mH																																															

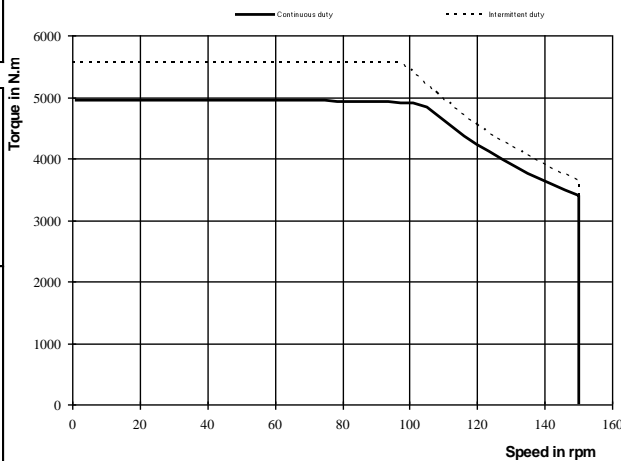

The permanent current I₀ of the motor is **122 Arms** for **4950Nm** at low speed.
 The nominal current I_n of the motor is **122 Arms** for **4900 Nm** at the nominal speed.

Selection of the drive:

The datasheet shows a torque sensitivity of 40.5 Nm/Arms. This means that the drive has to provide at less 4500/40.5=111 Arms.
 In order to obtain an acceleration torque of **5500 Nm**, the current will be of about 135 Arms
 (the motor data sheet shows 5540 Nm with 138 Arms). This means that the drive has to provide at less 135 Arms as transient current.

→ Therefore, we can select the drive **AC890 PARKER SD-43 3105 F** which delivers under 400Vac:
126 Arms as permanent current and
 126*110%=138 Arms as maximal transient current during 60 s.
 Under these conditions, the drive runs with **“Quadratic as Servo Mode”**.

The example n°3 illustrates the situation where the motor observes a “derating” mode due to the current limitation set by the drive.

3.1.5. Current limitation at stall conditions (i.e. speed < 3 rpm)

Recommended reduced current at speed < 3 rpm:

$$I_{reduced} = \frac{1}{\sqrt{2}} * I_0 \cong 0.7 * I_0$$

	<p>Warning: The current must be limited to the prescribed values. If the nominal torque has to be maintained at stop or low speed (< 3 rpm), imperatively limit the current to 70% of I_0 (permanent current at low speed), in order to avoid an excessive overheating of the motor.</p>
--	---

	<p>Please refer to the drive technical documentation for any further information and to choose functions to program the drive.</p>
--	--

3.1.6. Peak current limitations

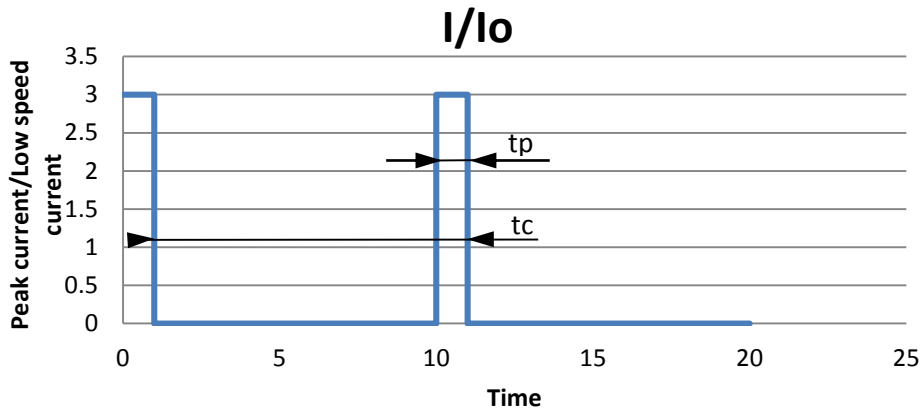

It is possible to use the TK motors with a current higher than the permanent current. But, to avoid any overheating, the following rules must be respected.

- 1) The peak currents and peak torques given in the data sheet must never be exceeded
- 2) The thermal equivalent torque must be respected (§3.1.3)
- 3) If 1) and 2) are respected (it can limit the peak current value or duration), the peak current duration (t_p) must be limited, in addition, accordingly to the following table (I_0 is the permanent current at low speed):

	$I_p/I_0 = 2$	$I_p/I_0 = 3$	$I_p/I_0 = 4$	$I_p/I_0 = 5$
TKA	$T_{peak} < 4s$	$T_{peak} < 1.7s$	$T_{peak} < 0.9s$	$T_{peak} < 0.5s$

	$I_p/I_0 = 1.5$	$I_p/I_0 = 2$	$I_p/I_0 = 2.5$	$I_p/I_0 > 2.5$
TKW	$T_{peak} < 2s$	$T_{peak} < 0.8$	$T_{peak} < 0.5s$	Not allowed

The peak current duration is calculated for a temperature rise of 3°C
Consult us for more demanding applications.

3.2. TK Characteristics: Torque, speed, current, power...

The torque vs speed graph below explains different intrinsic values of the next tables.

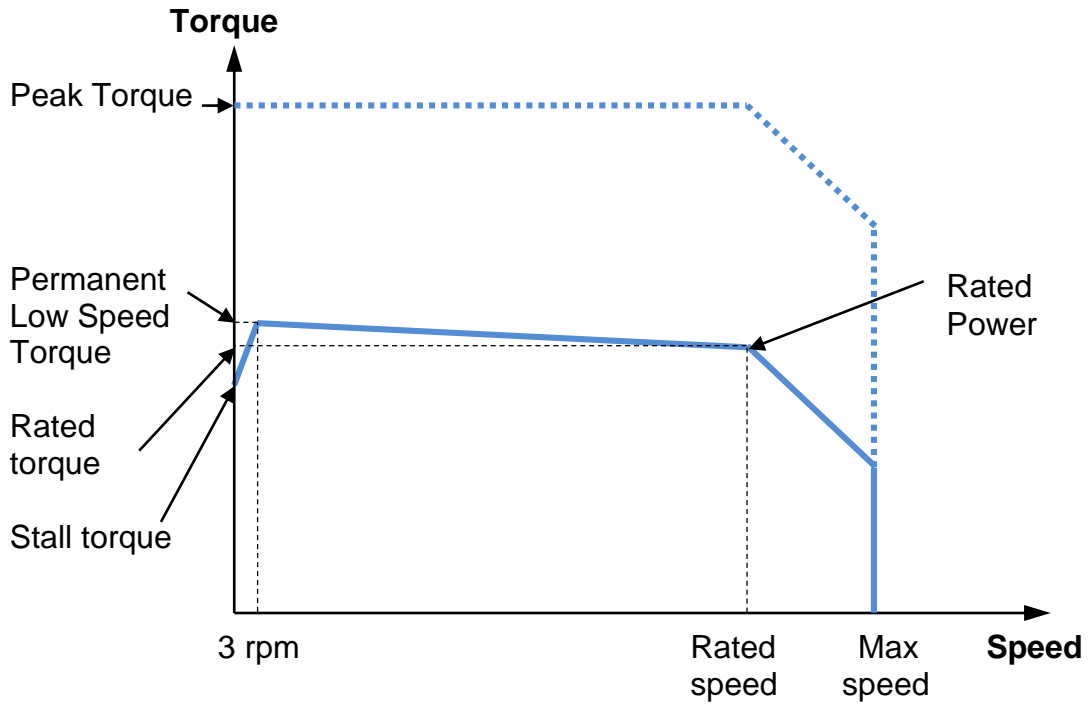

3.2.1. TKA - Natural cooling - Mains voltage 3 AC 400 V

Motor	Rated Power P _n [kW]	Rated Torque M _n [Nm]	Rated Current I _n [Arms]	Rated Speed N _n [rpm]	Low speed torque M _o [Nm]	Low speed Current I _o [Arms]	Peak Torque M _{peak} [Nm]	Peak Current I _{peak} [Arms]	Max. Speed N _{max} [rpm]
400 VAC power supply - three-phased - natural cooling									
TKA131HL	2,8	28	5,0	940	41	7,0	200	38,2	940
TKA132HL	4,5	70	8,3	610	85	9,8	415	54,2	610
TKA133HN	6,6	108	12,2	580	130	14,4	625	78,8	580
TKA134HN	7,4	154	13,8	460	175	15,4	850	85,9	460
TKA135HP	8,5	198	16	410	220	17,6	1060	97,0	410
TKA136HP	10,0	239	18,6	400	265	20,4	1280	113,0	400
TKA201HM	4,9	109	8,9	430	145	11,4	650	63,6	430
TKA202HS	8,0	246	14,5	310	300	17,3	1300	93,2	310
TKA203HR	9,8	398	18,1	235	455	20,3	1950	108,0	235
TKA204HV	10,5	558	20	180	610	21,6	2600	114,0	180
TKA205HU	12,5	705	23,5	170	770	25,5	3250	134,0	170
TKA206HS	16,6	832	31,7	190	925	34,7	3900	182,0	190
TKA208HS	17,0	1160	32,9	140	1240	34,9	5200	182,0	140
TKA301HJ	7,1	273	13	250	350	16,2	1200	57,6	250
TKA302HP	11,4	604	20,7	180	720	24,2	2400	83,6	180
TKA303HN	14,9	948	27,9	150	1100	31,8	3600	108,0	150
TKA304HN	20,8	1240	38,6	160	1470	45,0	4800	152,0	160
TKA305HN	24,1	1590	44,8	145	1850	51,4	6000	173,0	145
TKA306HM	26,6	1950	49,1	130	2220	55,0	7200	185,0	130
TKA308HL	28,5	2720	55,1	100	2970	59,5	9600	199,0	100
TKA30AHL	29,3	3490	56,4	80	3710	59,4	12000	199,0	80
TKA401HG	12,6	604	22,6	200	820	29,7	3300	145,0	200
TKA402HP	20,4	1260	37	155	1640	47,0	6600	229,0	155
TKA403HL	27,4	1940	48,7	135	2460	60,4	9900	295,0	135
TKA404HR	30,5	2770	55,9	105	3270	64,9	13200	317,0	105
TKA405HQ	33,7	3570	62,2	90	4070	70,0	16500	344,0	90
TKA406HP	36,6	4370	69	80	4880	76,3	19800	375,0	80
TKA408HN	46,0	5850	84,7	75	6490	93,0	26400	459,0	75
TKA40AHM	49,3	7470	91,5	63	8100	98,3	33000	486,0	63
TKA40CHK	58,1	9400	109	59	10100	116,0	39600	550,0	59

3.2.2. TKW - Water cooling - Mains voltage 3 AC 400 V

Motor	Rated Power P _n [kW]	Rated Torque M _n [Nm]	Rated Current I _n [Arms]	Rated Speed N _n [rpm]	Low speed torque M _o [Nm]	Low speed Current I _o [Arms]	Peak Torque M _{peak} [Nm]	Peak Current I _{peak} [Arms]	Max. Speed N _{max} [rpm]
400 VAC power supply - three-phased - water cooled									
TKW131HL	6,9	88,3	15,1	750	90	15,2	200	38,2	1120
TKW131HC	17,9	68,2	35,1	2500	90	44,3	200	111,0	2800
TKW132HL	10,1	201	23	480	205	23,4	415	54,2	720
TKW132HF	22,2	189	47,5	1120	205	50,6	415	118,0	1680
TKW133HN	14,8	314	34,7	450	320	35,2	625	78,8	675
TKW133HH	30,7	299	66,7	980	320	70,4	625	158,0	1470
TKW133HD	45,3	278	93,8	1550	320	106	625	236,0	2320
TKW134HN	15,3	431	37,9	340	435	38	850	85,9	510
TKW134HJ	27,8	422	63,2	630	435	64,6	850	146,0	945
TKW134HF	46,4	402	101	1100	435	108	850	243,0	1650
TKW135HM	27,7	540	64,8	490	550	65,4	1060	146,0	735
TKW135HG	54,0	515	116	1000	550	123	1060	273,0	1500
TKW136HM	31,0	656	72,9	450	660	72,7	1280	163,0	675
TKW136HF	71,2	616	155	1100	660	164	1280	367,0	1650
TKW201HF	20,6	219	39,9	900	275	48,6	650	143,0	1000
TKW201HM	10,0	262	20,8	365	275	21,6	650	63,6	540
TKW202HF	45,0	480	87,7	895	610	108	1300	286,0	1040
TKW202HS	15,8	592	34,5	255	610	35,3	1300	93,2	380
TKW203HD	57,5	819	115	670	960	133	1950	334,0	940
TKW203HE	53,7	835	108	614	960	123	1950	308,0	905
TKW203HR	18,2	936	42,2	185	960	43,2	1950	108,0	275
TKW204HI	71,1	1140	145	595	1300	163	2600	401,0	890
TKW204HV	18,9	1280	46,1	140	1300	46,5	2600	114,0	170
TKW205HH	80,7	1480	167	520	1650	184	3250	445,0	780
TKW205HM	51,8	1570	113	316	1650	118	3250	286,0	470
TKW205HU	22,2	1630	54,6	130	1650	55,1	3250	134,0	195
TKW206HG	92,0	1810	192	485	2000	209	3900	501,0	725
TKW206HM	51,3	1920	116	255	2000	120	3900	286,0	380
TKW206HS	31,0	1960	75	150	2000	76,1	3900	182,0	225
TKW208HF	106,0	2500	226	405	2700	242	5200	572,0	605
TKW208HM	50,9	2630	119	185	2700	121	5200	286,0	275
TKW208HS	29,4	2670	76,6	105	2700	77,1	5200	182,0	135

Motor	Rated Power Pn [kW]	Rated Torque Mn [Nm]	Rated Current In [Arms]	Rated Speed Nn [rpm]	Low speed torque Mo [Nm]	Low speed Current Io [Arms]	Peak Torque Mpeak [Nm]	Peak Current I peak [Arms]	Max. Speed Nmax [rpm]
400 VAC power supply - three-phased - water cooled									
TKW301HB	36,1	497	67,4	695	680	87,6	1200	162,0	695
TKW301HJ	14,7	651	30,2	215	680	31,1	1200	57,6	320
TKW302HE	64,0	1290	124	475	1520	143	2400	235,0	605
TKW302HJ	46,0	1390	91,6	315	1520	98,2	2400	162,0	470
TKW302HP	23,2	1480	49,7	150	1520	50,7	2400	83,5	220
TKW303HC	83,2	2120	166	375	2380	183	3600	288,0	550
TKW303HJ	47,8	2270	99,1	200	2380	103	3600	162,0	295
TKW303HN	30,5	2330	67,4	125	2380	68,4	3600	108,0	185
TKW304HG	96,4	2970	196	310	3250	211	4800	324,0	465
TKW304HM	51,1	3150	110	155	3250	112	4800	173,0	230
TKW304HN	44,8	3160	97,1	135	3250	99,1	4800	152,0	195
TKW305HG	99,2	3870	203	245	4100	213	6000	324,0	360
TKW305HN	50,6	4030	112	120	4100	113	6000	173,0	175
TKW305HO	42,4	4050	99,3	100	4100	100	6000	152,0	125
TKW306HF	113,0	4710	235	230	4950	245	7200	370,0	340
TKW306HM	53,9	4900	122	105	4950	122	7200	185,0	150
TKW306HO	41,3	4930	101	80	4950	101	7200	152,0	120
TKW308HC	141,0	6400	296	211	6740	309	9600	457,0	315
TKW308HL	55,7	6650	133	80	6740	135	9600	199,0	115
TKW308HO	39,3	6690	103	56	6740	103	9600	152,0	80
TKW30AHD	162,0	8110	340	190	8450	351	12000	518,0	280
TKW30AHL	52,0	8420	135	59	8450	135	12000	199,0	70
TKW30AHO	35,4	8450	104	40	8450	103	12000	152,0	60
TKW401HA	45,6	1150	87,2	380	1460	108	3300	295,0	415
TKW401HG	24,4	1370	50,5	169	1460	53	3300	145,0	255
TKW402HG	78,8	2840	158	265	3270	180	6600	434,0	375
TKW402HI	69,0	2930	141	225	3270	155	6600	375,0	335
TKW402HP	42,5	3110	90,9	130	3270	94,8	6600	229,0	195
TKW403HC	106,0	4590	215	220	5100	237	9900	550,0	325
TKW403HJ	66,3	4860	142	130	5100	148	9900	344,0	195
TKW403HL	56,7	4910	123	110	5100	127	9900	295,0	160
TKW404HI	124,0	6400	260	185	6900	278	13200	635,0	275
TKW404HQ	63,7	6760	148	90	6900	151	13200	344,0	135
TKW404HR	60,3	6780	137	84,9	6900	139	13200	317,0	125
TKW405HH	134,0	8270	292	155	8800	308	16500	688,0	200
TKW405HQ	65,1	8630	152	72	8800	154	16500	344,0	105
TKW406HG	148,0	10100	324	140	10600	338	19800	750,0	210
TKW406HP	71,4	10500	168	65	10600	169	19800	375,0	95
TKW406HQ	63,9	10500	154	58	10600	155	19800	344,0	70
TKW408HF	166,0	13800	365	115	14400	379	26400	825,0	170
TKW408HN	84,8	14200	208	57	14400	211	26400	459,0	85
TKW408HQ	59,9	14300	157	40,1	14400	158	26400	344,0	60
TKW40AHE	184,0	17500	413	100	18100	424	33000	917,0	145
TKW40AHM	88,3	17900	223	47	18100	225	33000	486,0	70
TKW40AHQ	54,9	18100	159	29	18100	159	33000	344,0	40
TKW40CHD	207,0	21200	469	93	21900	482	39600	1030,0	135
TKW40CHK	97,5	21700	255	43	21900	257	39600	550,0	60

3.2.3. Further Data with natural cooling

Motor	Ke [Vrms/krpm]	Kt [Nm/Arms]	Winding Resistance [ohms]	Inductance [mH]	Moment of Inertia J [kgmm ²]	Motor Weight [kg]
Natural cooling						
TKA131HL	372	5,83	2,320	12,9	0,01	10
TKA132HL	553	8,67	2,070	14,3	0,02	20
TKA133HN	575	9,01	1,400	10,3	0,03	30
TKA134HN	724	11,3	1,580	12,3	0,04	40
TKA135HP	798	12,5	1,450	11,9	0,05	50
TKA136HP	830	13,0	1,300	10,8	0,06	60
TKA201HM	799	12,7	1,570	9,7	0,09	35
TKA202HS	1090	17,3	1,140	9,0	0,18	57
TKA203HR	1410	22,4	1,200	10,0	0,27	5
TKA204HV	1780	28,2	1,350	11,9	0,35	96
TKA205HU	1900	30,3	1,200	11,0	0,44	115
TKA206HS	1670	26,6	0,779	7,1	0,52	135
TKA208HS	2230	35,5	1,010	9,4	0,69	170
TKA301HJ	1370	21,6	1,200	6,9	0,6	75
TKA302HP	1880	29,7	0,880	6,6	1,2	113
TKA303HN	2190	34,6	0,703	5,9	1,7	150
TKA304HN	2070	32,6	0,452	4,0	2,3	185
TKA305HN	2280	36,0	0,424	3,9	2,9	230
TKA306HM	2550	40,3	0,424	4,0	3,4	270
TKA308HL	3160	49,9	0,499	4,6	4,6	345
TKA30AHL	3950	62,4	0,632	5,8	5,7	425
TKA401HG	1730	27,6	0,558	4,3	1,9	130
TKA402HP	2190	34,9	0,337	3,5	3,5	202
TKA403HL	2550	40,7	0,287	3,1	5,2	275
TKA404HR	3160	50,4	0,319	3,6	6,8	345
TKA405HQ	3640	58,2	0,333	3,8	8,5	420
TKA406HP	4010	64,0	0,318	3,9	10,1	490
TKA408HN	4370	69,8	0,276	3,5	13,4	630
TKA40AHM	5160	82,4	0,315	3,9	16,7	770
TKA40CHK	5470	87,3	0,274	3,6	20	915

3.2.4. Further Data with water cooling

Motor	Ke [Vrms/krpm]	Kt (sine) [Nm/Arms]	Winding Resistance [ohms]	Inductance [mH]	Moment of Inertia J [kgmm ²]	Motor Weight [kg]	Water Flow [l/min]
Water cooled							
TKW131HL	372	5,93	2,320	13,1	0,01	15	1,8
TKW131HC	128	2,03	0,272	1,5	0,01	15	2,4
TKW132HL	553	8,77	2,070	14,3	0,02	20	3,4
TKW132HF	255	4,05	0,436	3,0	0,02	20	3,7
TKW133HN	575	9,10	1,400	10,3	0,03	35	5,3
TKW133HH	287	4,55	0,343	2,6	0,03	35	5,5
TKW133HD	192	3,03	0,150	1,1	0,03	35	6,0
TKW134HN	724	11,4	1,580	12,2	0,04	45	7,0
TKW134HJ	426	6,73	0,552	4,2	0,04	45	7,2
TKW134HF	255	4,04	0,191	1,5	0,04	45	7,4
TKW135HM	532	8,4	0,671	5,2	0,05	55	8,9
TKW135HG	284	4,48	0,188	1,5	0,05	55	9,3
TKW136HM	575	9,08	0,625	5,1	0,06	65	11
TKW136HF	255	4,03	0,121	1,0	0,06	65	12
TKW201HF	355	5,66	0,308	1,9	0,09	35	2,9
TKW201HM	799	12,7	1,570	9,6	0,09	35	2,4
TKW202HF	355	5,63	0,126	0,9	0,18	60	5,8
TKW202HS	1090	17,3	1,140	8,9	0,18	57	4,6
TKW203HD	457	7,21	0,130	1,1	0,27	78	8,0
TKW203HE	495	7,81	0,143	1,2	0,27	78	7,9
TKW203HR	1410	22,2	1,200	10,0	0,27	75	6,8
TKW204HI	507	8,0	0,113	1,0	0,35	98	10
TKW204HV	1780	28,0	1,350	11,8	0,35	98	8,9
TKW205HH	571	8,98	0,109	1,0	0,44	120	13
TKW205HM	888	14,0	0,268	2,3	0,44	120	12
TKW205HU	1900	29,9	1,200	10,8	0,44	120	11
TKW206HG	609	9,56	0,101	0,9	0,52	140	15
TKW206HM	1070	16,7	0,315	2,8	0,52	140	14
TKW206HS	1670	26,3	0,779	6,9	0,52	140	13
TKW208HF	710	11,2	0,103	0,9	0,69	173	19
TKW208HM	1420	22,3	0,410	3,7	0,69	173	18
TKW208HS	2230	35,0	1,010	9,1	0,69	173	18

Motor	Ke [Vrms/krpm]	Kt (sine) [Nm/Arms]	Winding Resistance [ohms]	Inductance [mH]	Moment of Inertia J [kgmm ²]	Motor Weight [kg]	Water Flow [l/min]
Water cooled							
TKW301HB	486	7,76	0,142	0,9	0,6	75	4,8
TKW301HJ	1370	21,8	1,130	6,9	0,6	75	3,6
TKW302HE	668	10,6	0,107	0,8	1,2	116	8,4
TKW302HJ	972	15,5	0,227	1,7	1,2	113	7,6
TKW302HP	1880	30,0	0,880	6,5	1,2	113	7,0
TKW303HC	820	13,0	0,098	0,8	1,7	153	12
TKW303HJ	1460	23,2	0,312	2,6	1,7	150	11
TKW303HN	2190	34,8	0,703	5,8	1,7	150	10
TKW304HG	972	15,4	0,099	0,9	2,3	192	15
TKW304HM	1820	28,9	0,349	3,0	2,3	192	14
TKW304HN	2070	32,8	0,452	3,9	2,3	192	14
TKW305HG	1220	19,3	0,121	1,1	2,9	238	18
TKW305HN	2280	36,2	0,424	3,8	2,9	238	17
TKW305HO	2580	41,0	0,549	4,8	2,9	238	17
TKW306HF	1280	20,2	0,110	1,0	3,4	280	22
TKW306HM	2550	40,5	0,424	3,9	3,4	274	21
TKW306HO	3100	49,2	0,646	5,8	3,4	274	21
TKW308HC	1380	21,8	0,093	0,9	4,6	375	29
TKW308HL	3160	50,1	0,499	4,5	4,6	350	27
TKW308HO	4130	65,5	0,839	7,7	4,6	350	27
TKW30AHD	1520	24,1	0,089	0,8	5,7	470	36
TKW30AHL	3950	62,6	0,614	5,6	5,7	430	34
TKW30AHO	5160	81,8	1,030	9,7	5,7	430	34
TKW401HA	850	13,5	0,132	1,0	1,9	137	5,8
TKW401HG	1730	27,5	0,558	4,3	1,9	137	5,0
TKW402HG	1150	18,2	0,095	0,9	3,5	209	11
TKW402HI	1340	21,1	0,128	1,3	3,5	209	10
TKW402HP	2190	34,5	0,337	3,4	3,5	208	9,8
TKW403HC	1370	21,5	0,082	0,9	5,2	280	16
TKW403HJ	2190	34,4	0,206	2,3	5,2	280	15
TKW403HL	2550	40,1	0,274	3,1	5,2	280	14
TKW404HI	1580	24,8	0,075	0,9	6,8	350	20
TKW404HQ	2920	45,8	0,258	3,0	6,8	350	19
TKW404HR	3160	49,6	0,300	3,5	6,8	350	19
TKW405HH	1820	28,5	0,083	0,9	8,5	430	25
TKW405HQ	3640	57,1	0,333	3,8	8,5	430	24
TKW406HG	2000	31,4	0,082	0,9	10,1	500	30
TKW406HP	4010	62,7	0,318	3,8	10,1	500	28
TKW406HQ	4370	68,5	0,391	4,5	10,1	500	28
TKW408HF	2430	38,0	0,085	1,0	13,4	640	39
TKW408HN	4370	68,3	0,276	3,4	13,4	640	38
TKW408HQ	5830	91,1	0,508	6,0	13,4	640	37
TKW40AHE	2730	42,7	0,085	1,1	16,7	780	48
TKW40AHM	5160	80,5	0,315	3,7	16,7	780	47
TKW40AHQ	7290	114	0,624	7,4	16,7	780	47
TKW40CHD	2920	45,4	0,080	1,0	20	920	58
TKW40CHK	5470	85,2	0,274	3,5	20	920	56

3.2.5. Efficiency curves



Caution: The efficiency curves are typical values. They may vary from one motor to an other



Caution: The efficiency curves are given for an optimal motor control (no voltage saturation and optimal phase between current and EMF)



Caution: The efficiency curves do not include the losses due to the switching frequency.



3.2.5.1. Series TKW131H

Motor mode

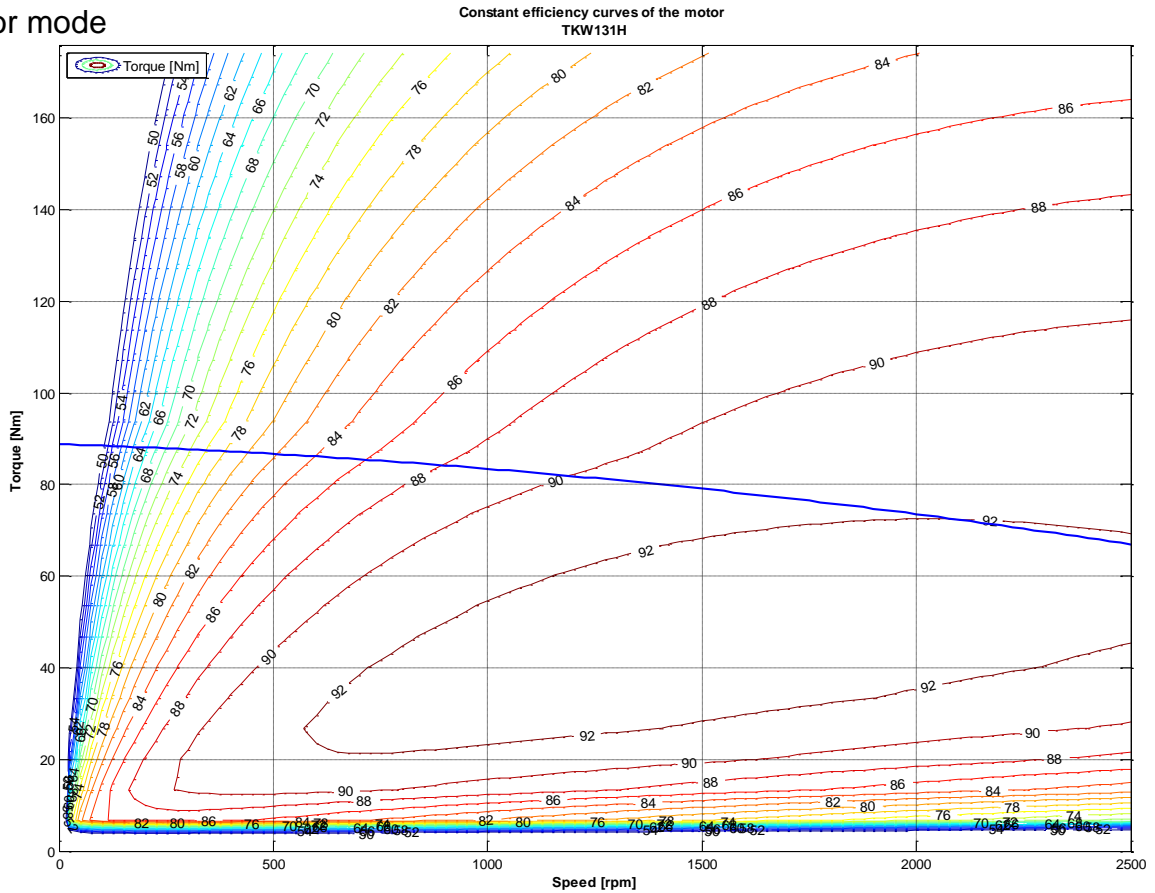

Generator mode

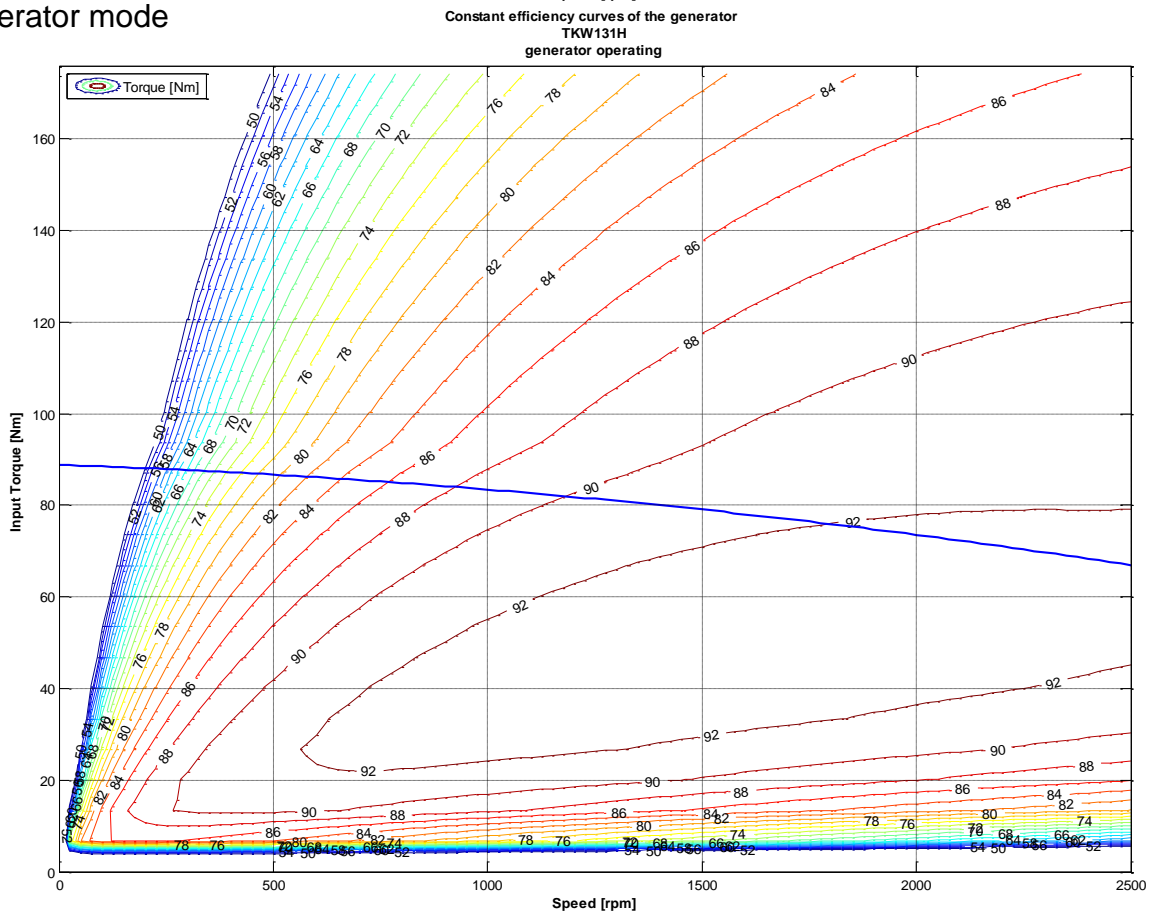



3.2.5.2. TKW132H

Motor mode

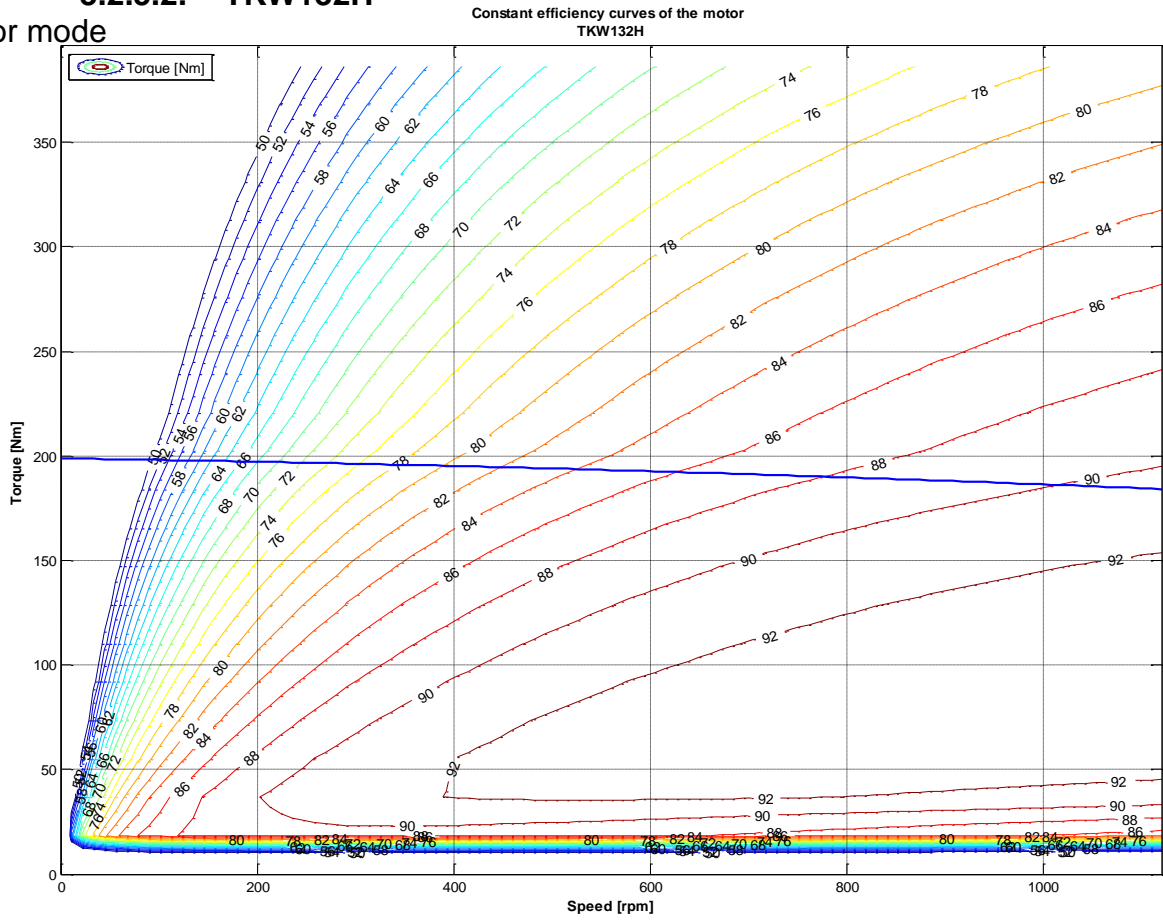

Generator mode

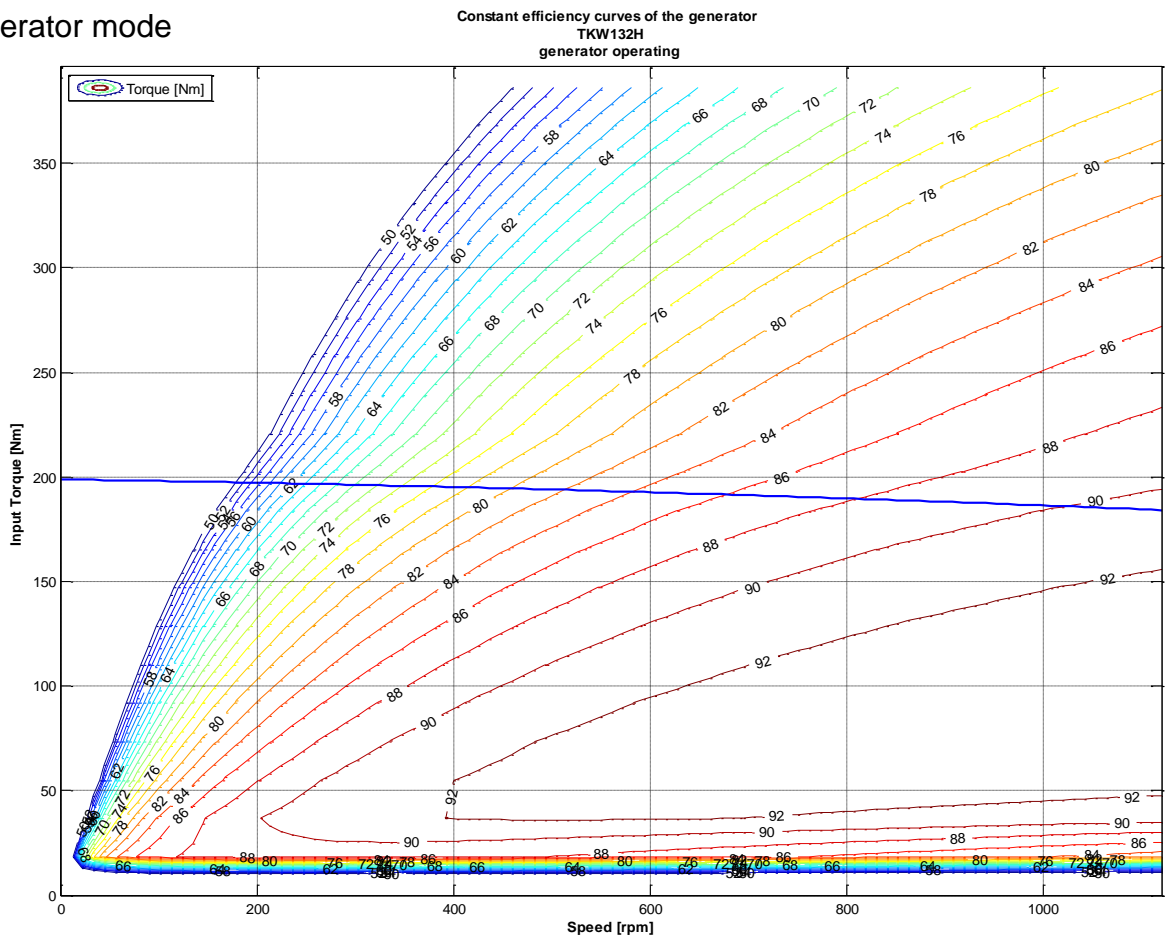



3.2.5.3. TKW133H

Motor mode

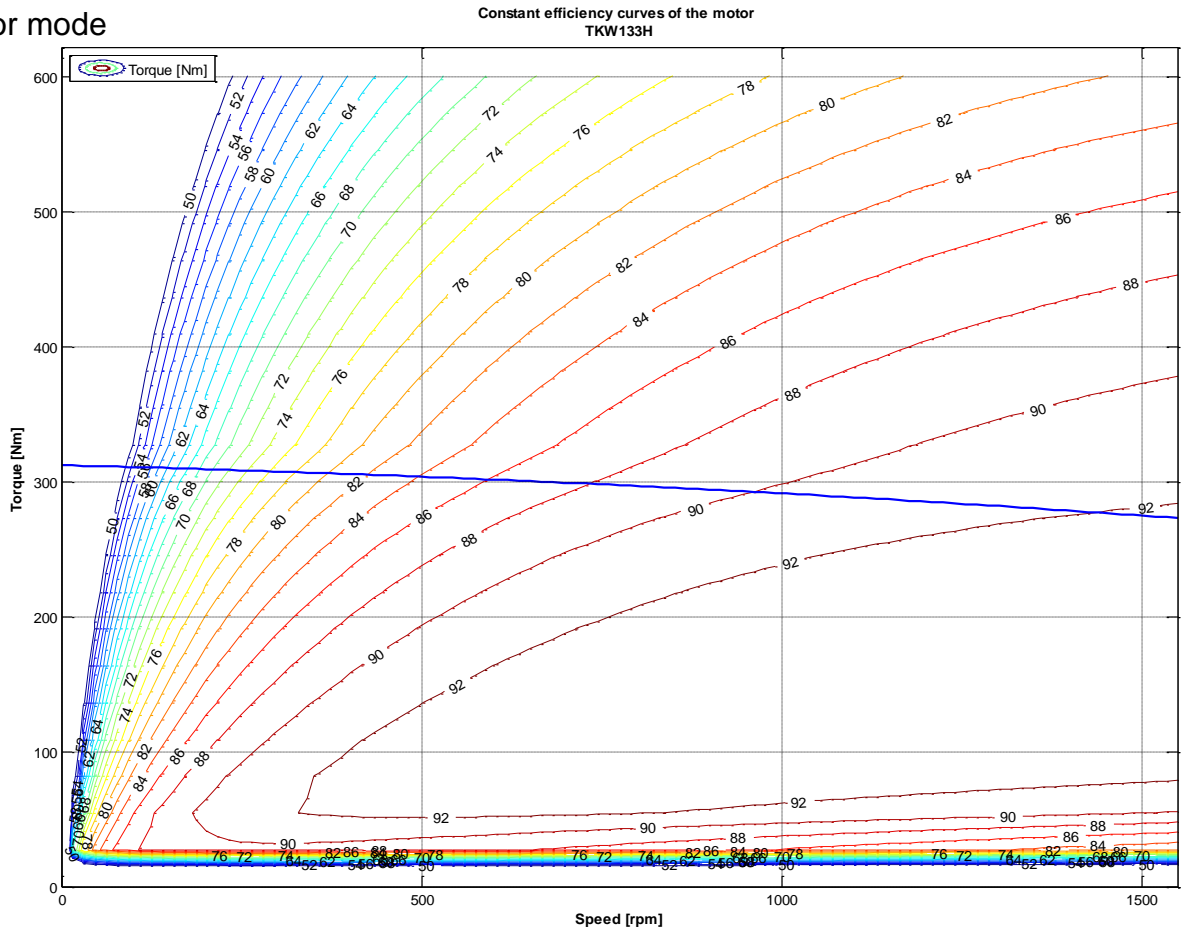

Generator mode

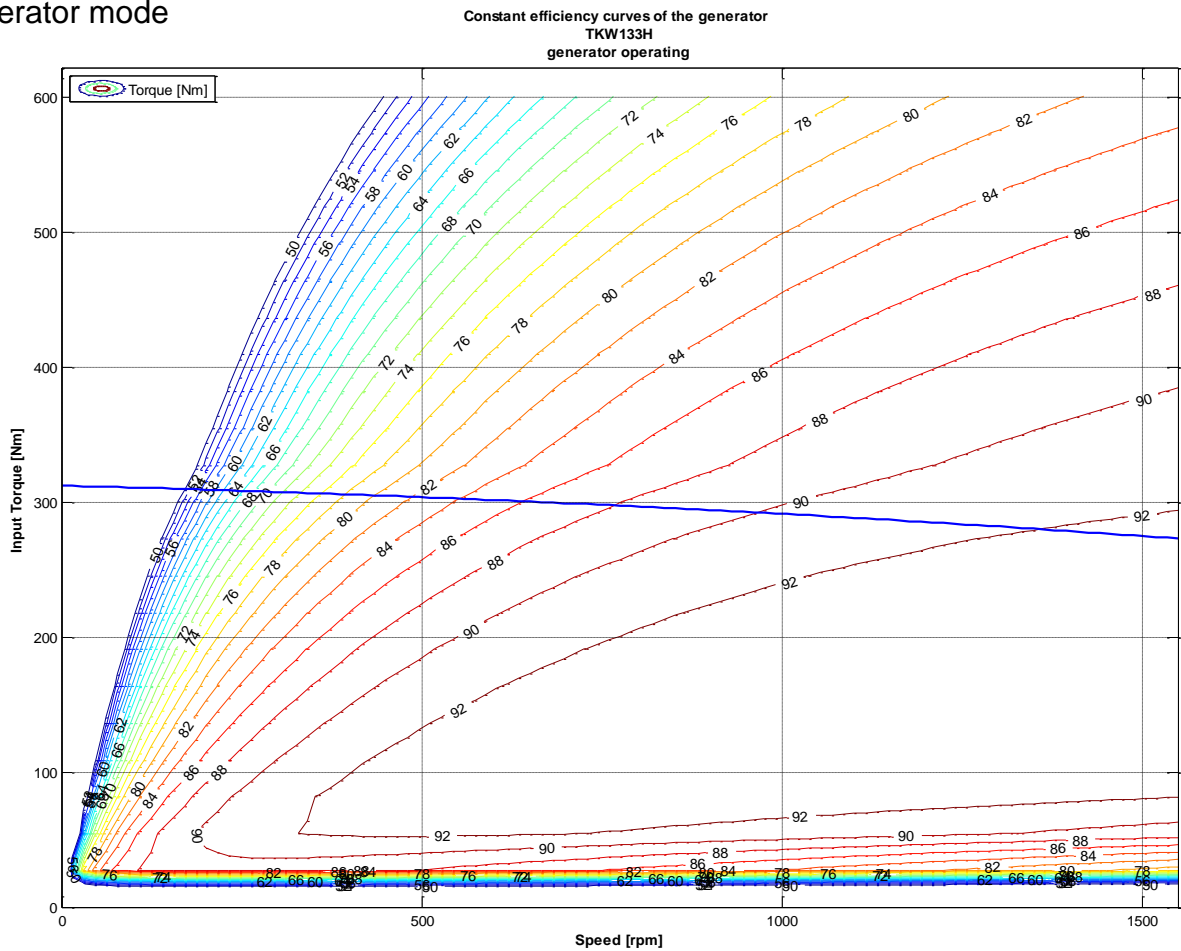



3.2.5.4. TKW134H

Motor mode

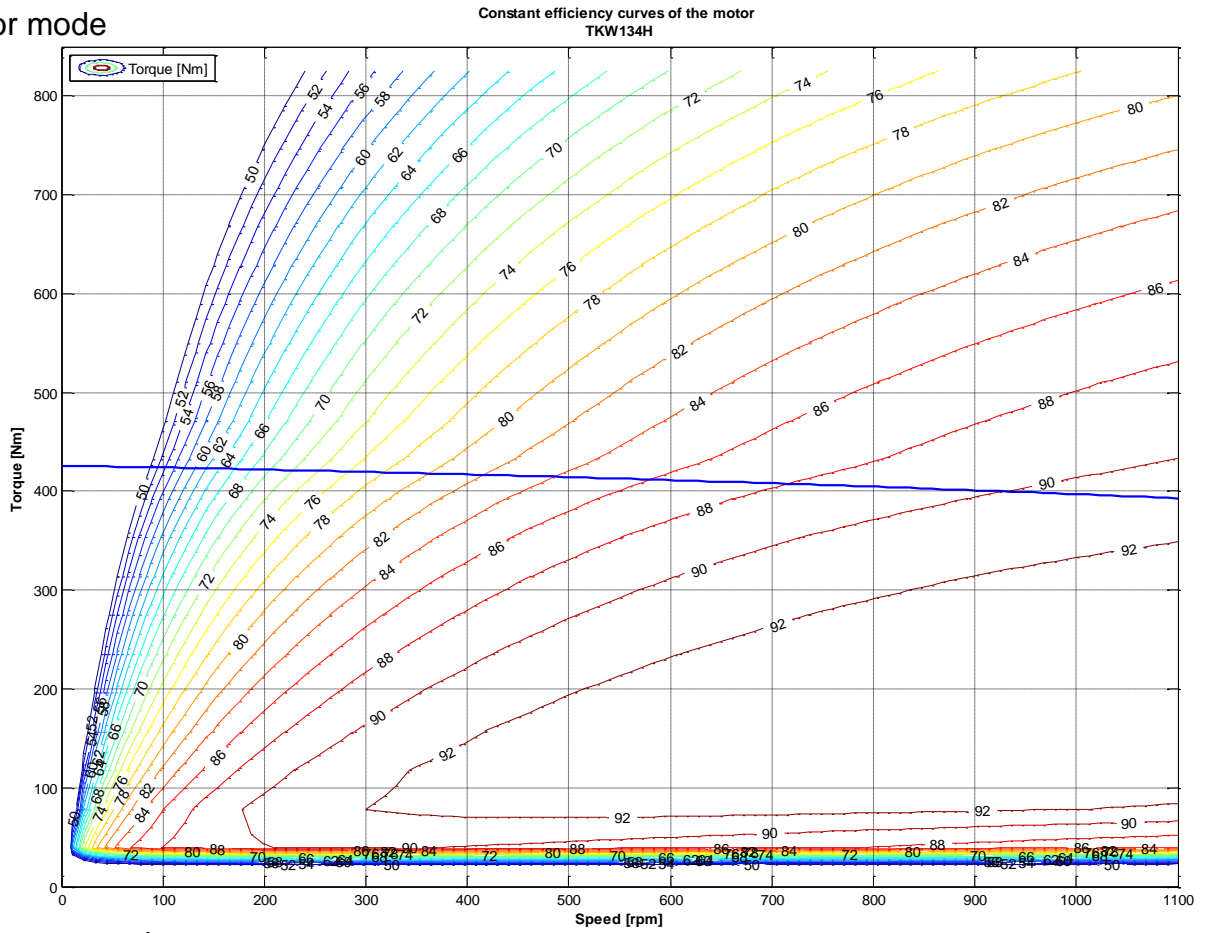

Generator mode

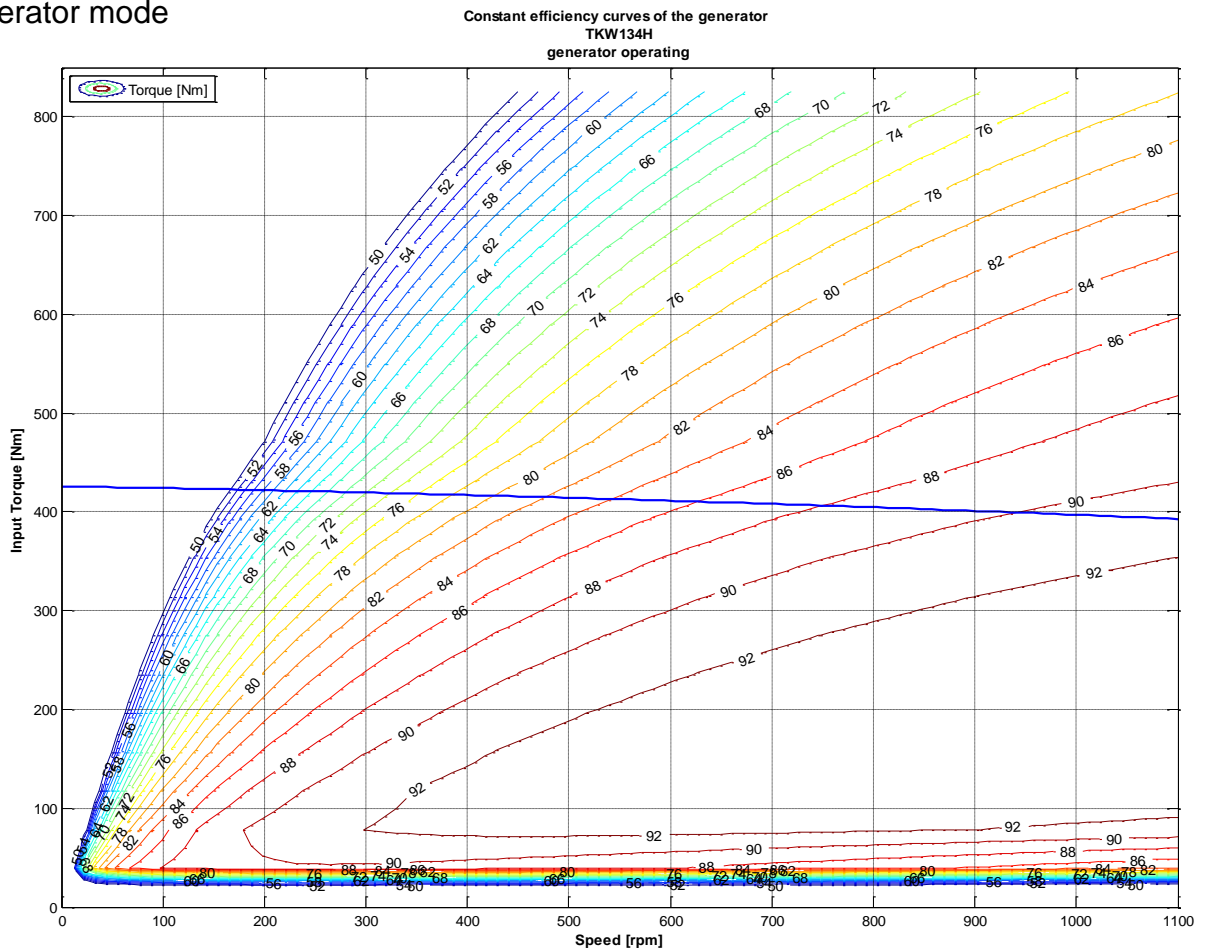



3.2.5.5. TKW135H

Motor mode

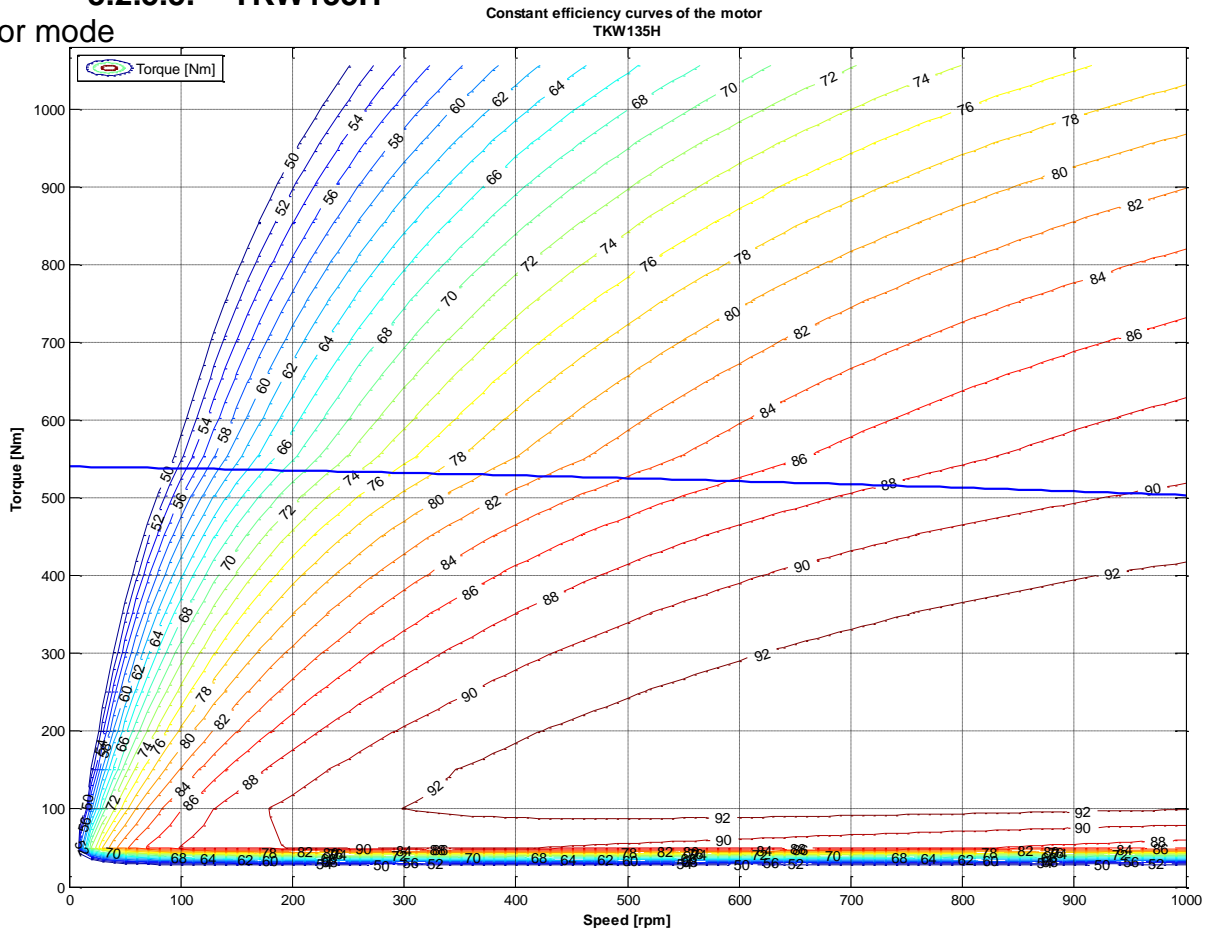

Generator mode

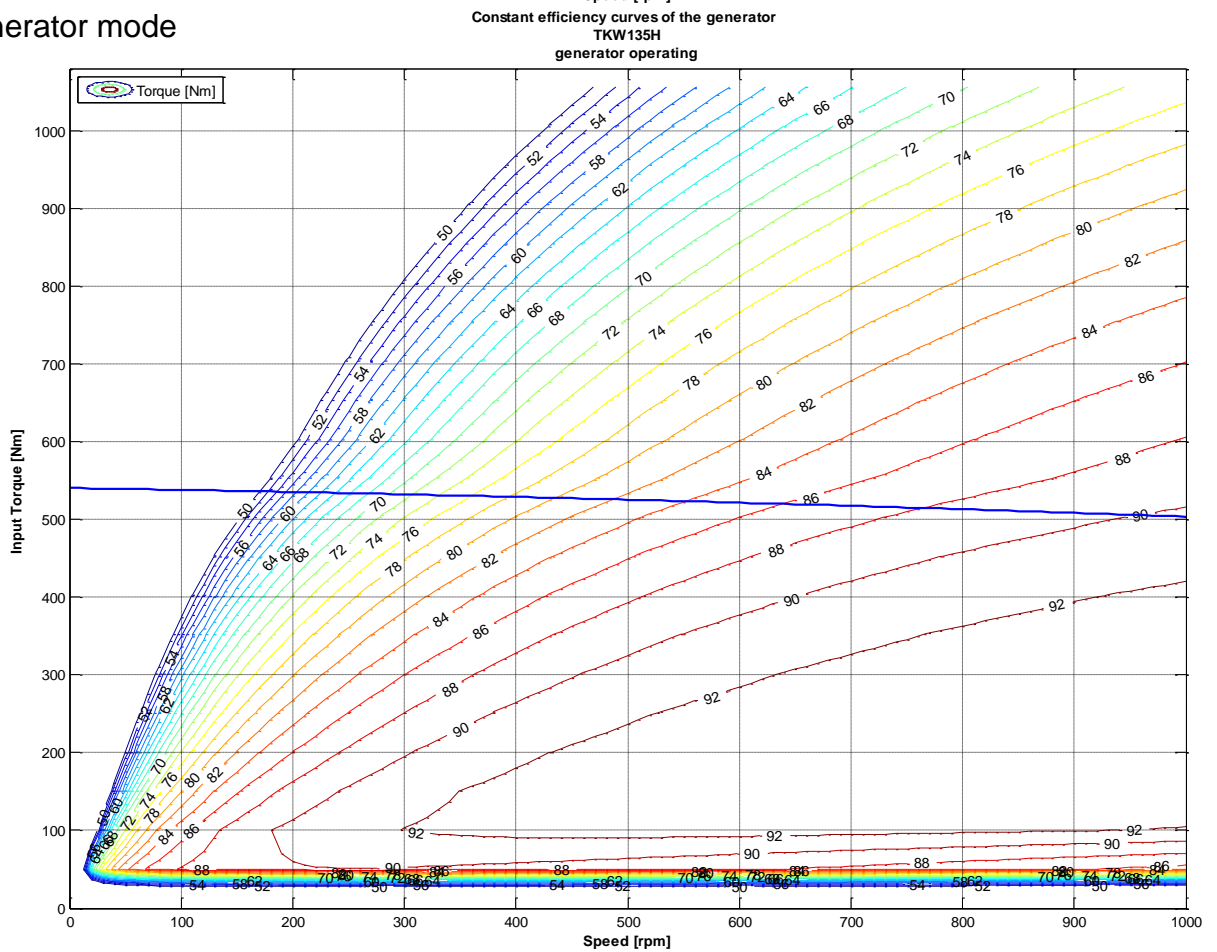



3.2.5.6. TKW136H

Motor mode

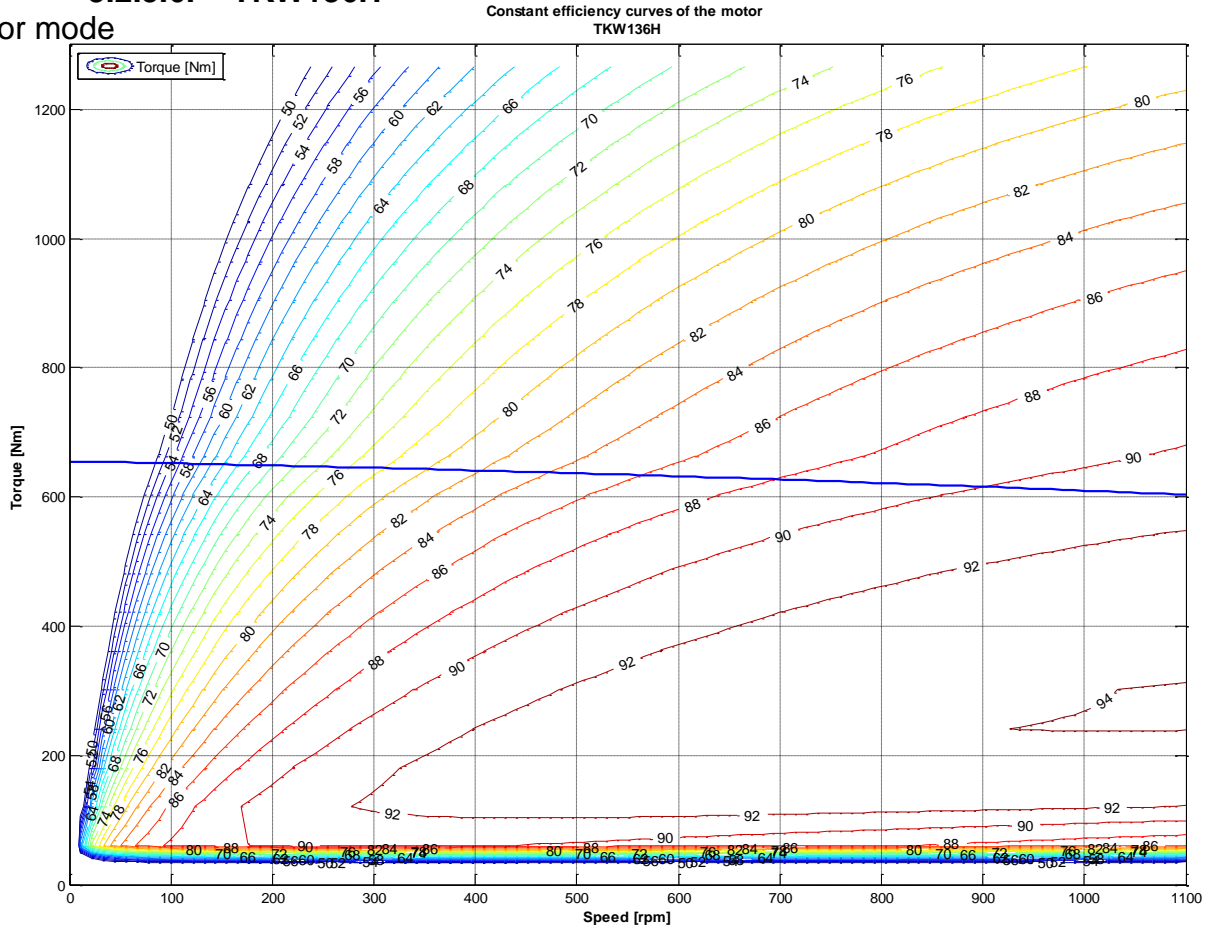

Generator mode

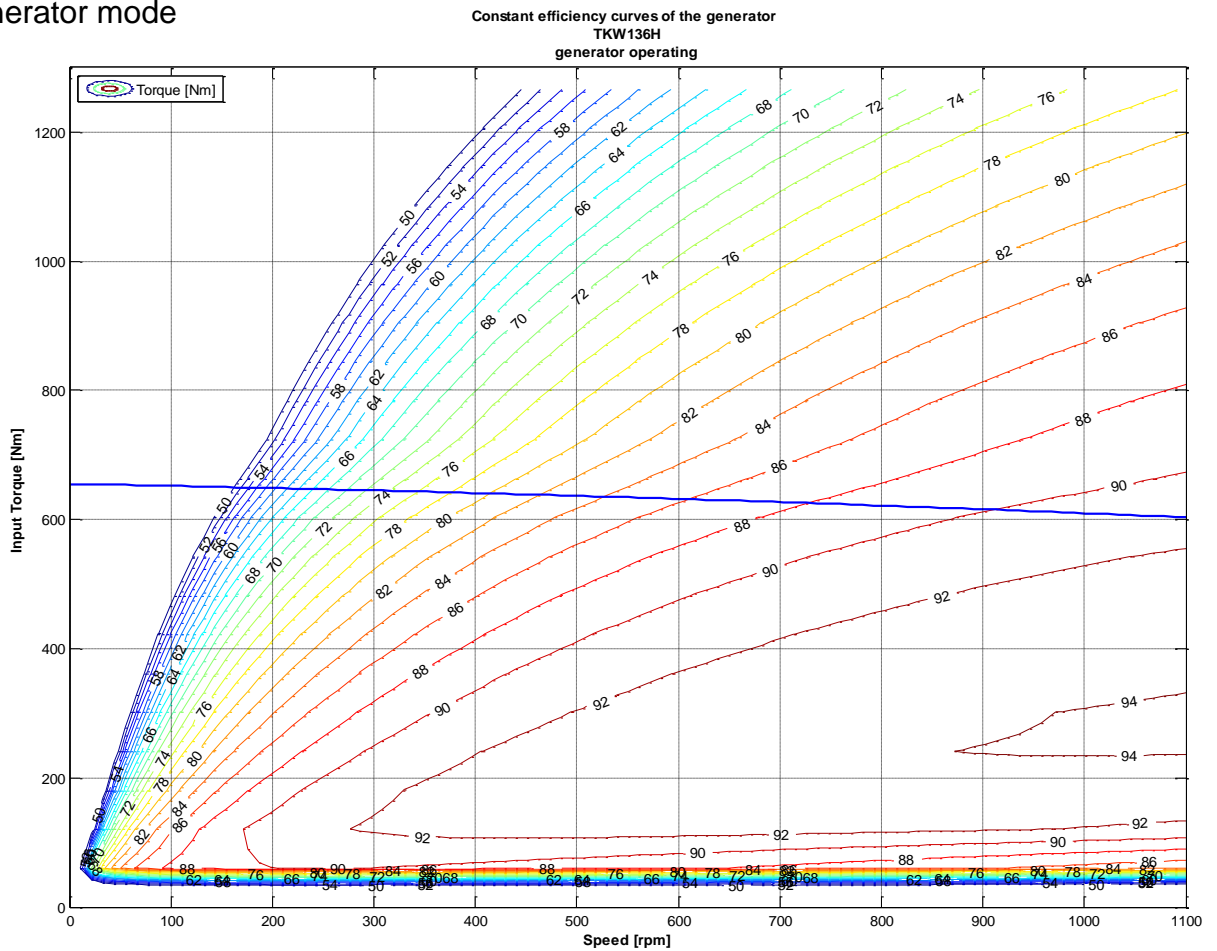



3.2.5.7. TKW201H

Motor mode

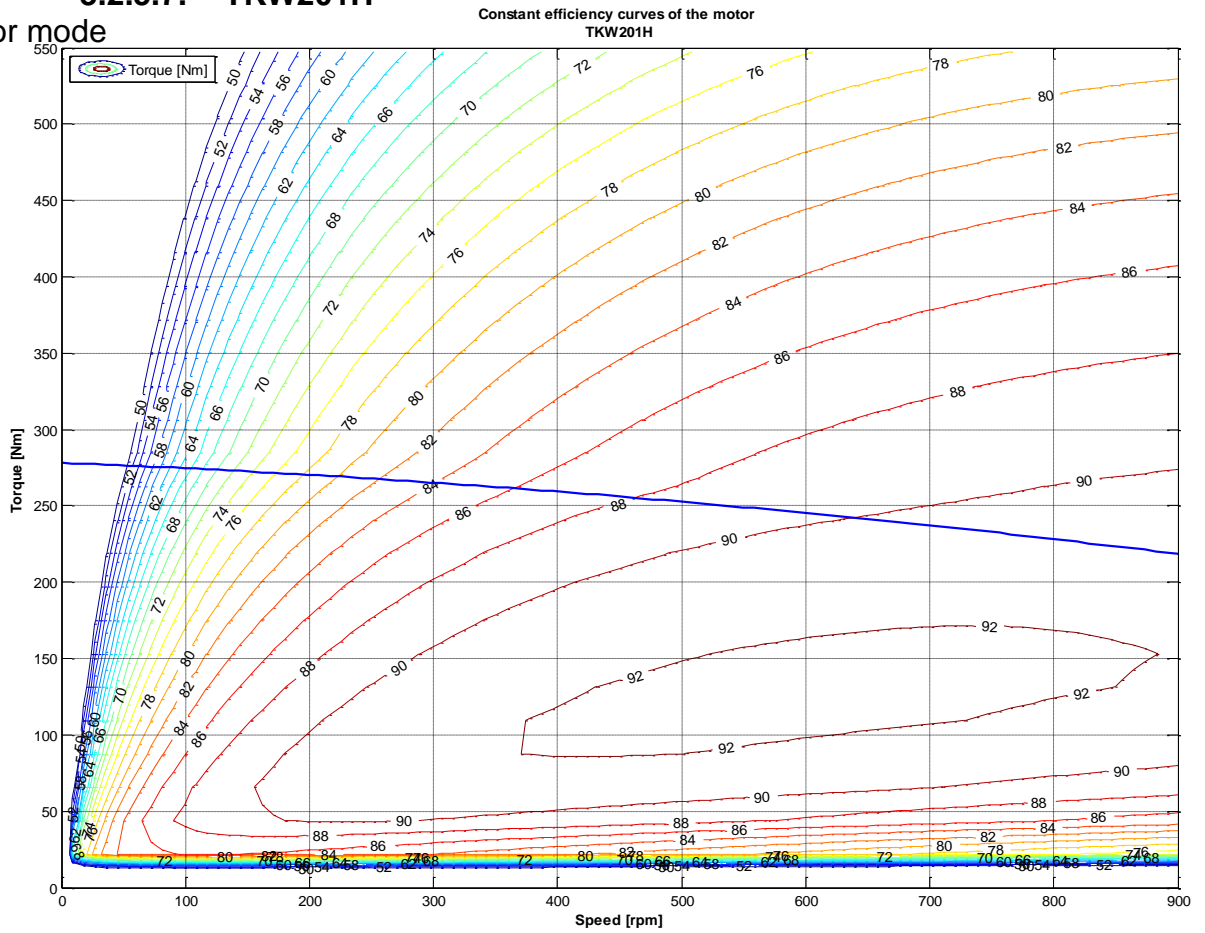

Generator mode

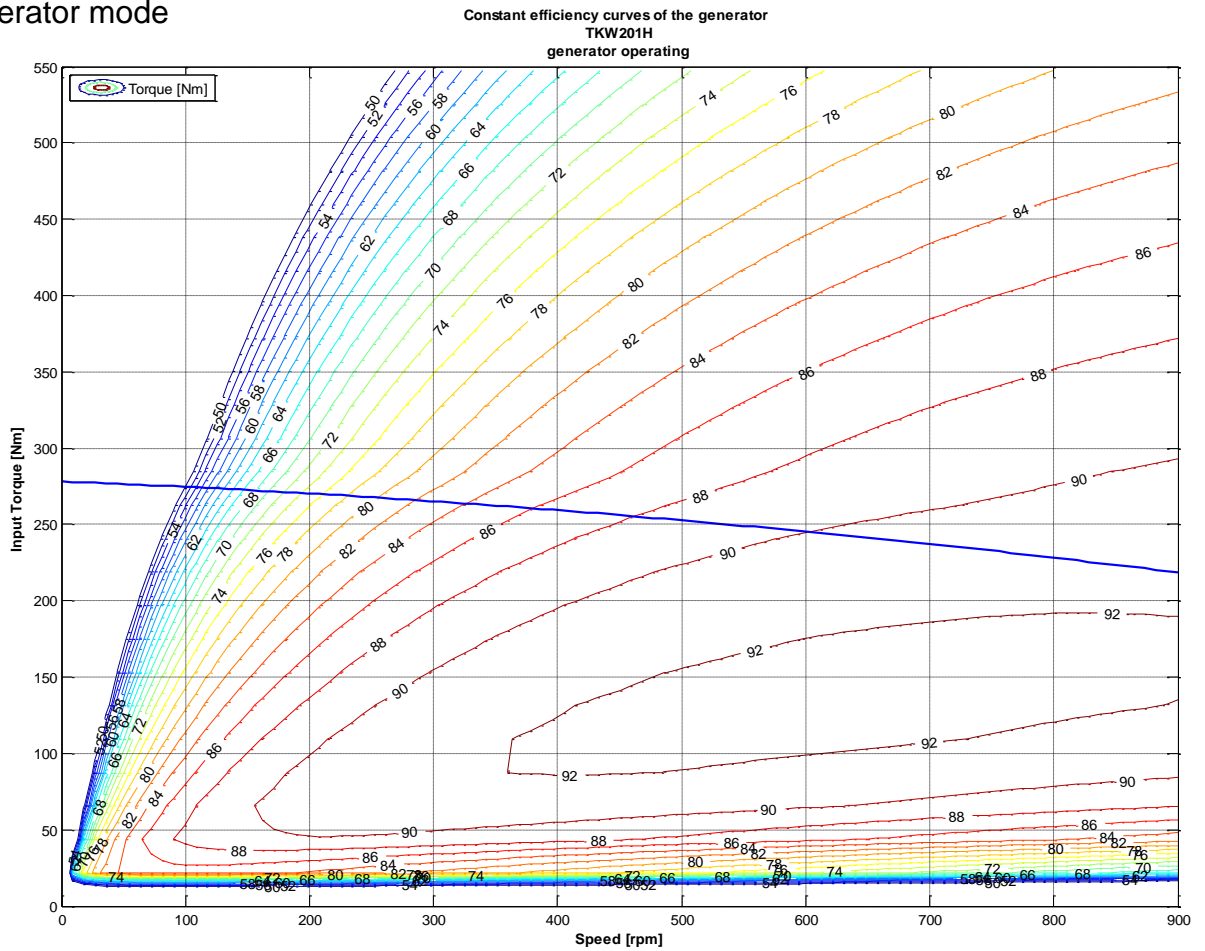



3.2.5.8. TKW202H

Motor mode

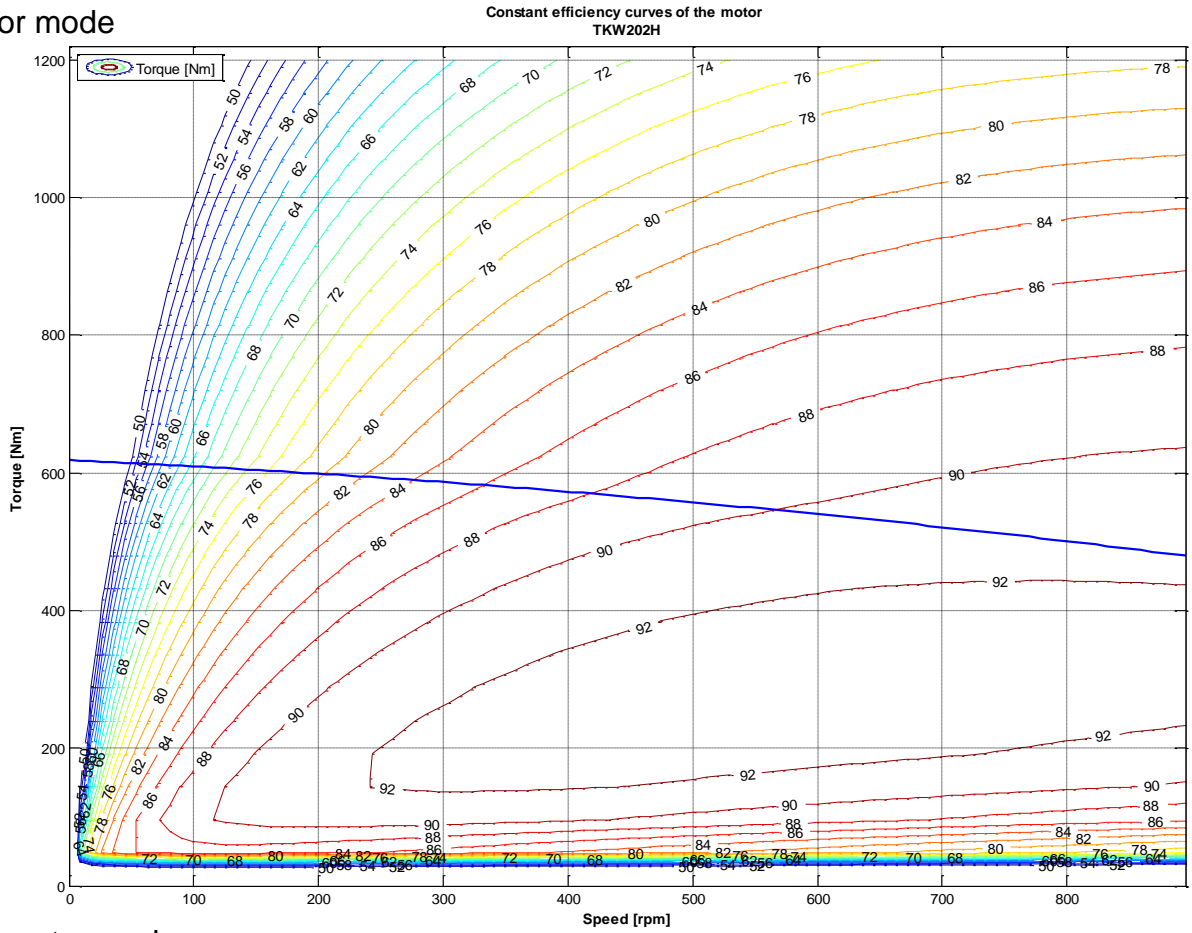

Generator mode

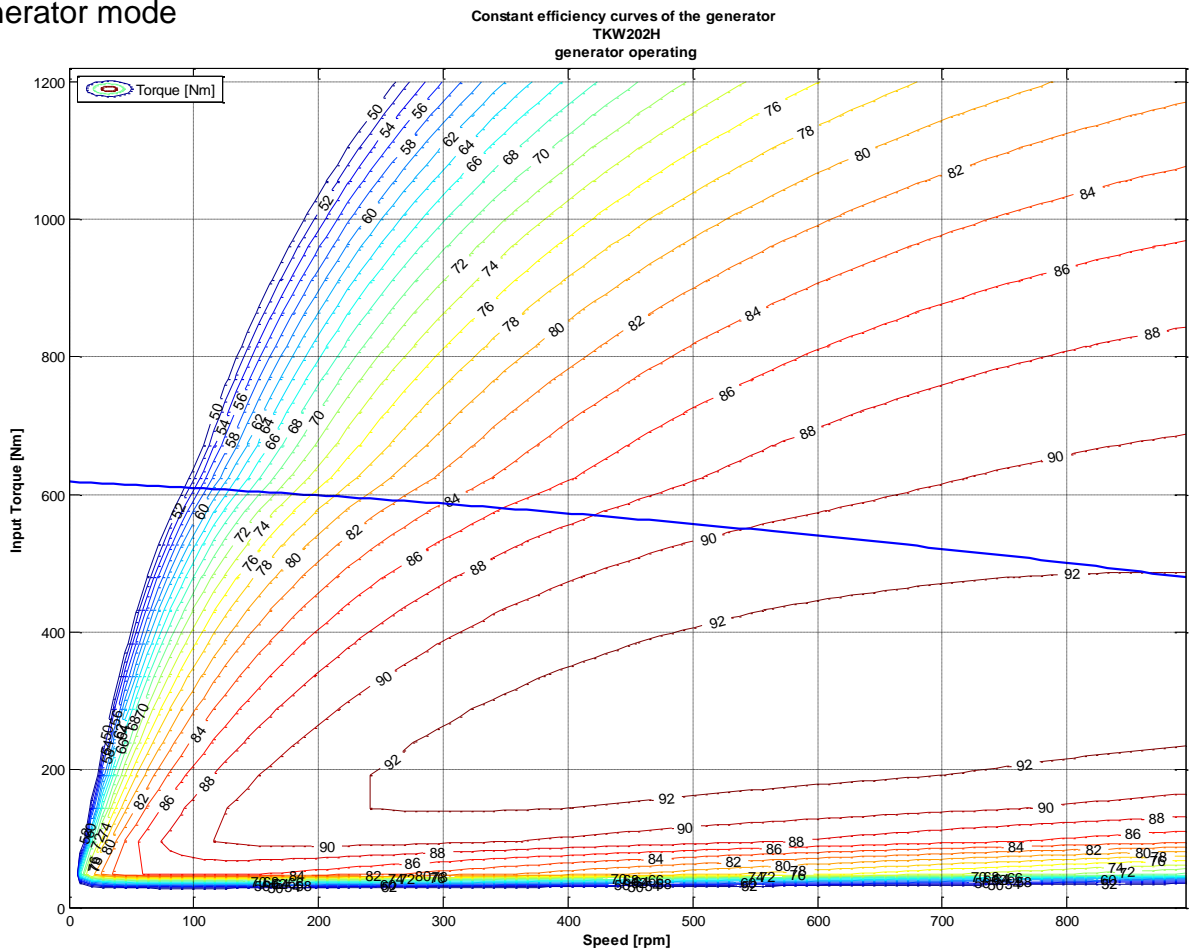



3.2.5.9. TKW203H

Motor mode

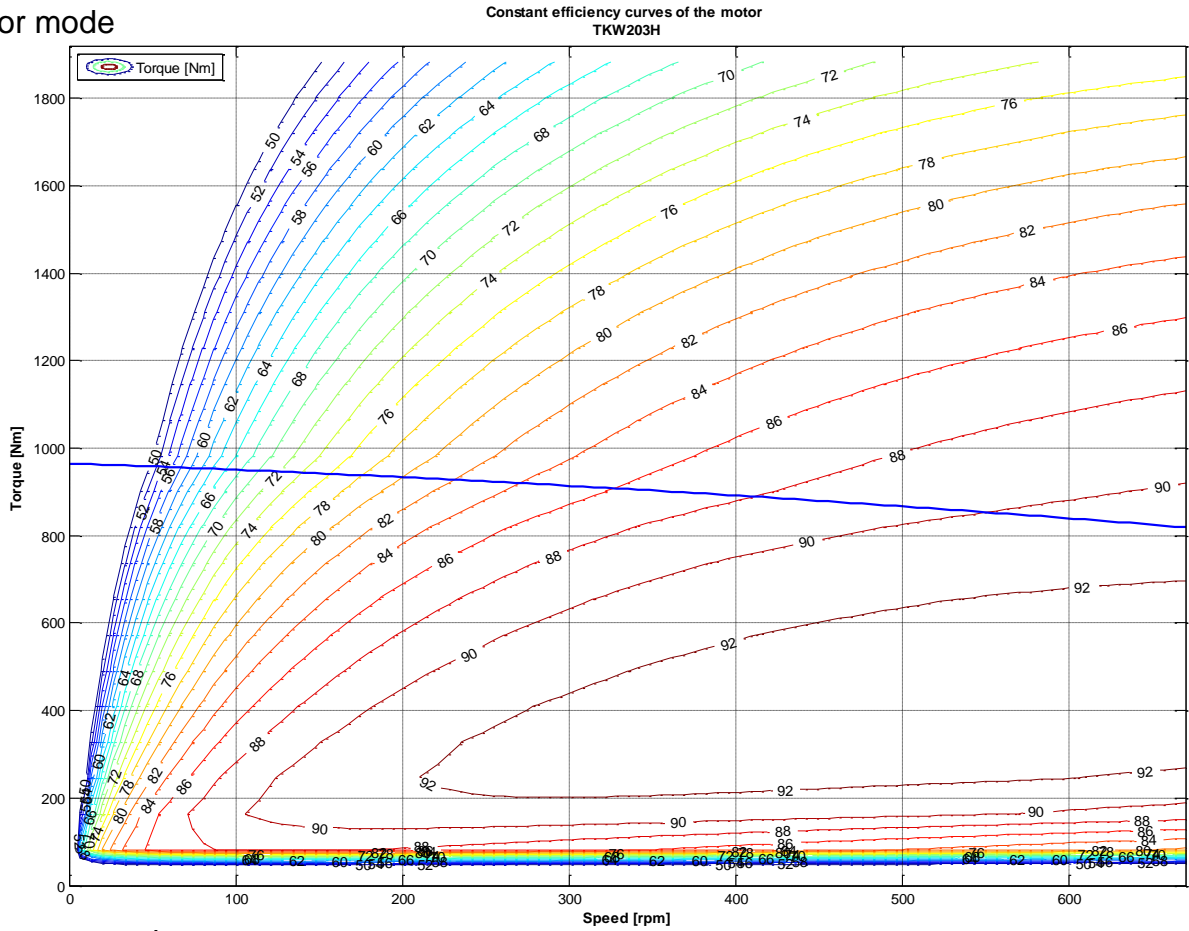

Generator mode

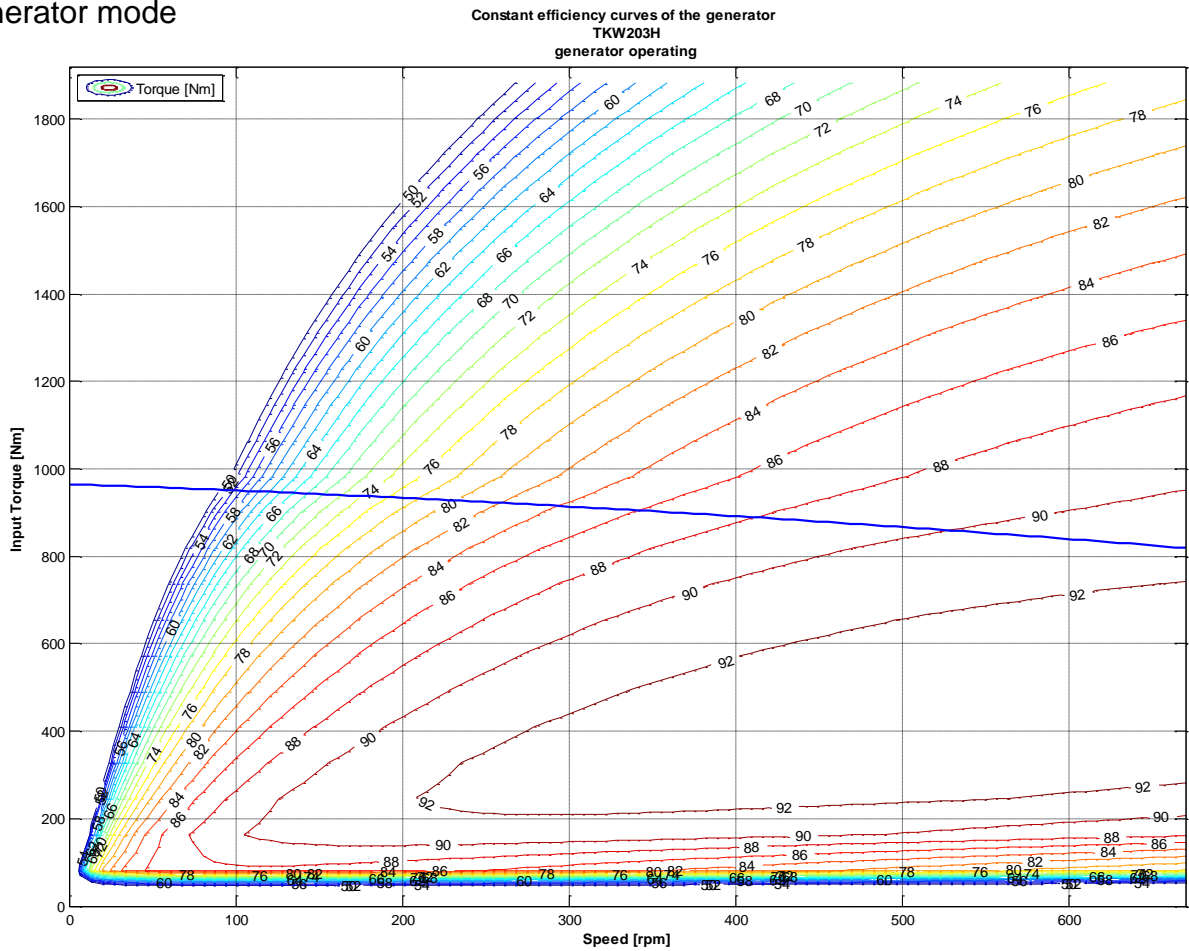

3.2.5.10. TKW204H

Motor mode

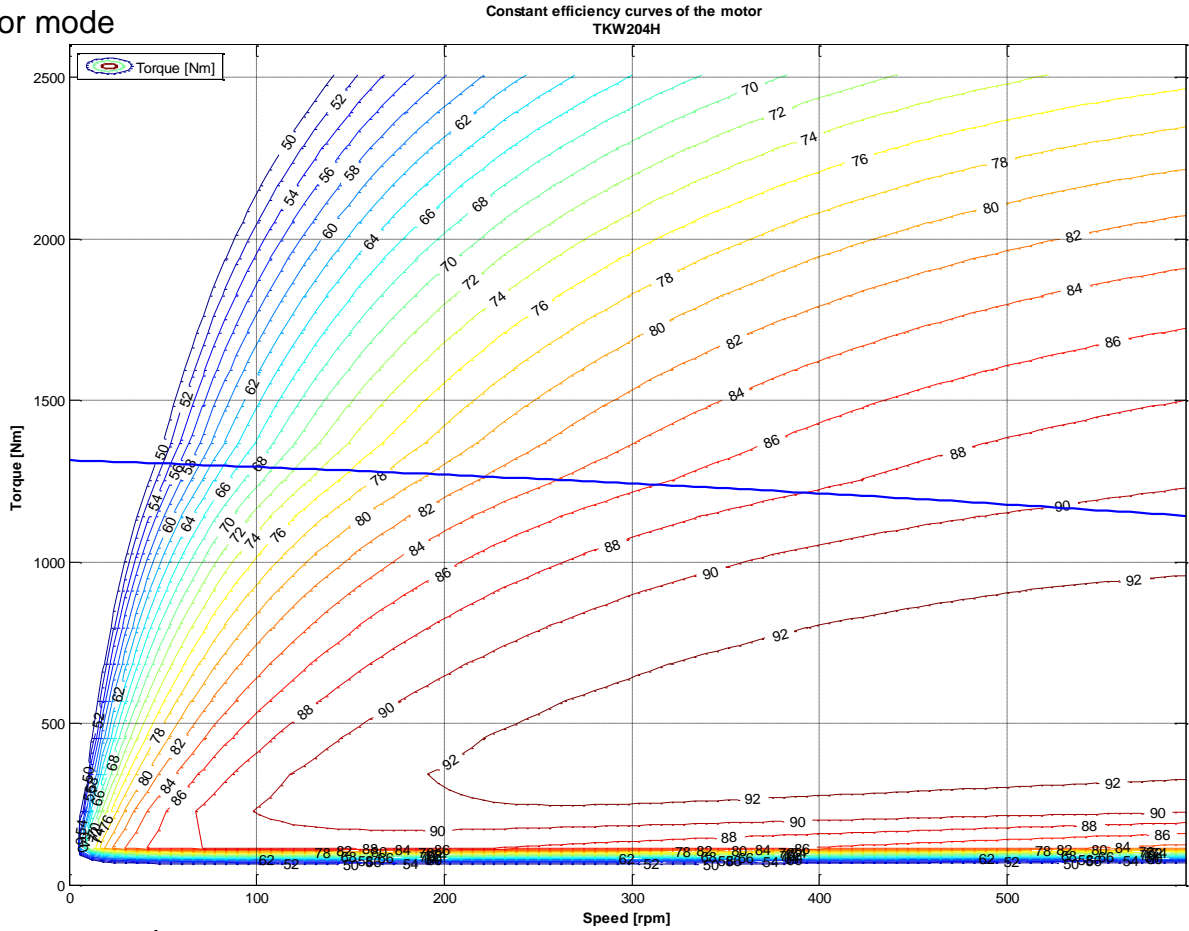

Generator mode

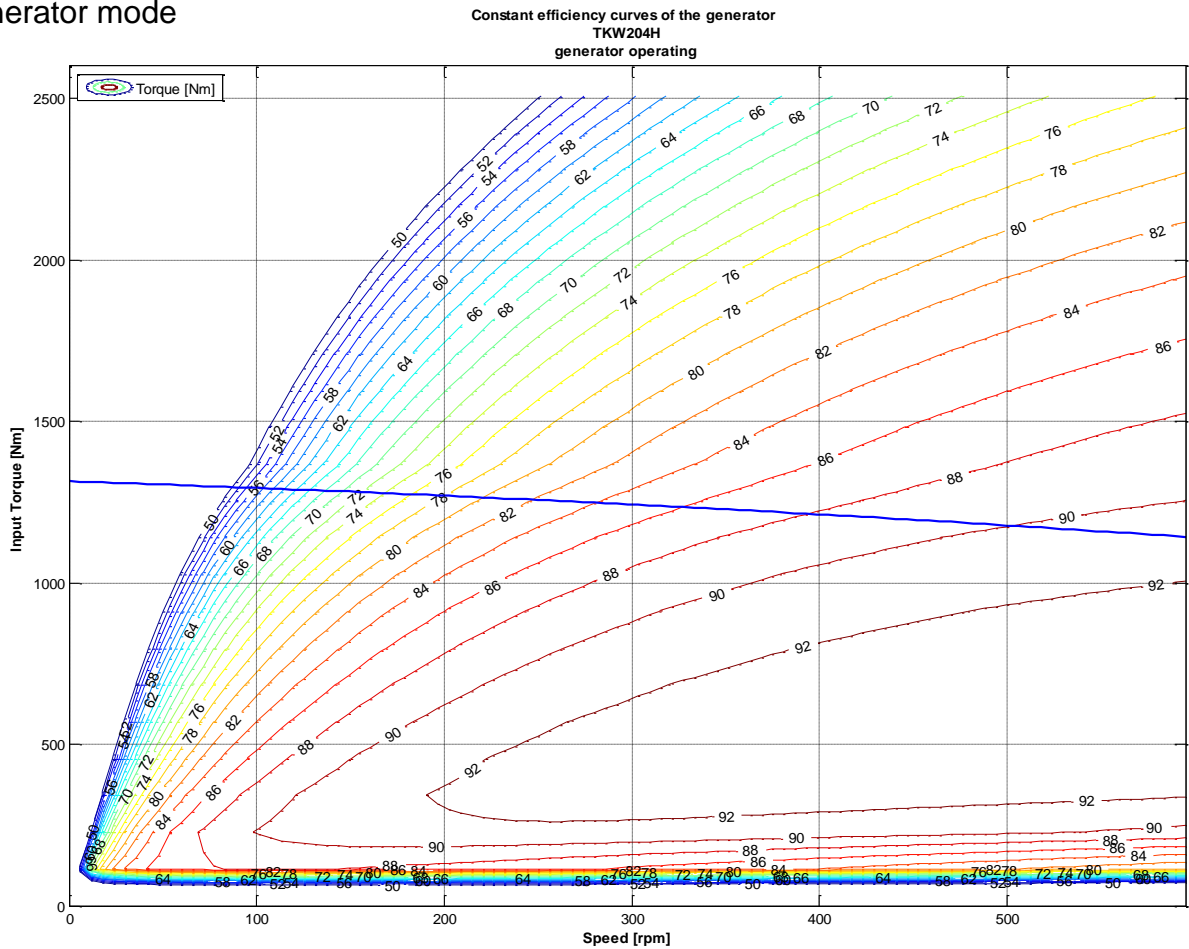



3.2.5.11. TKW205H

Motor mode

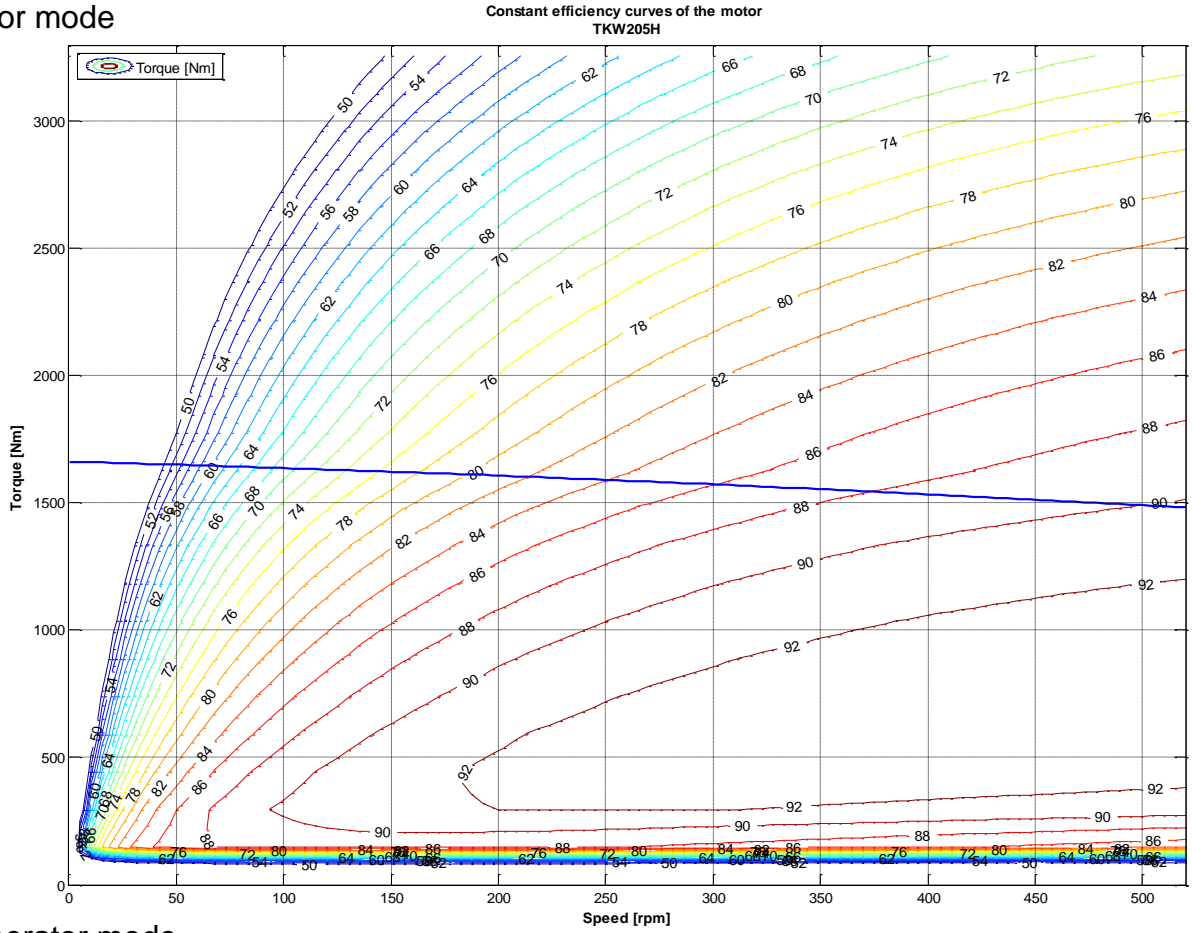

Generator mode

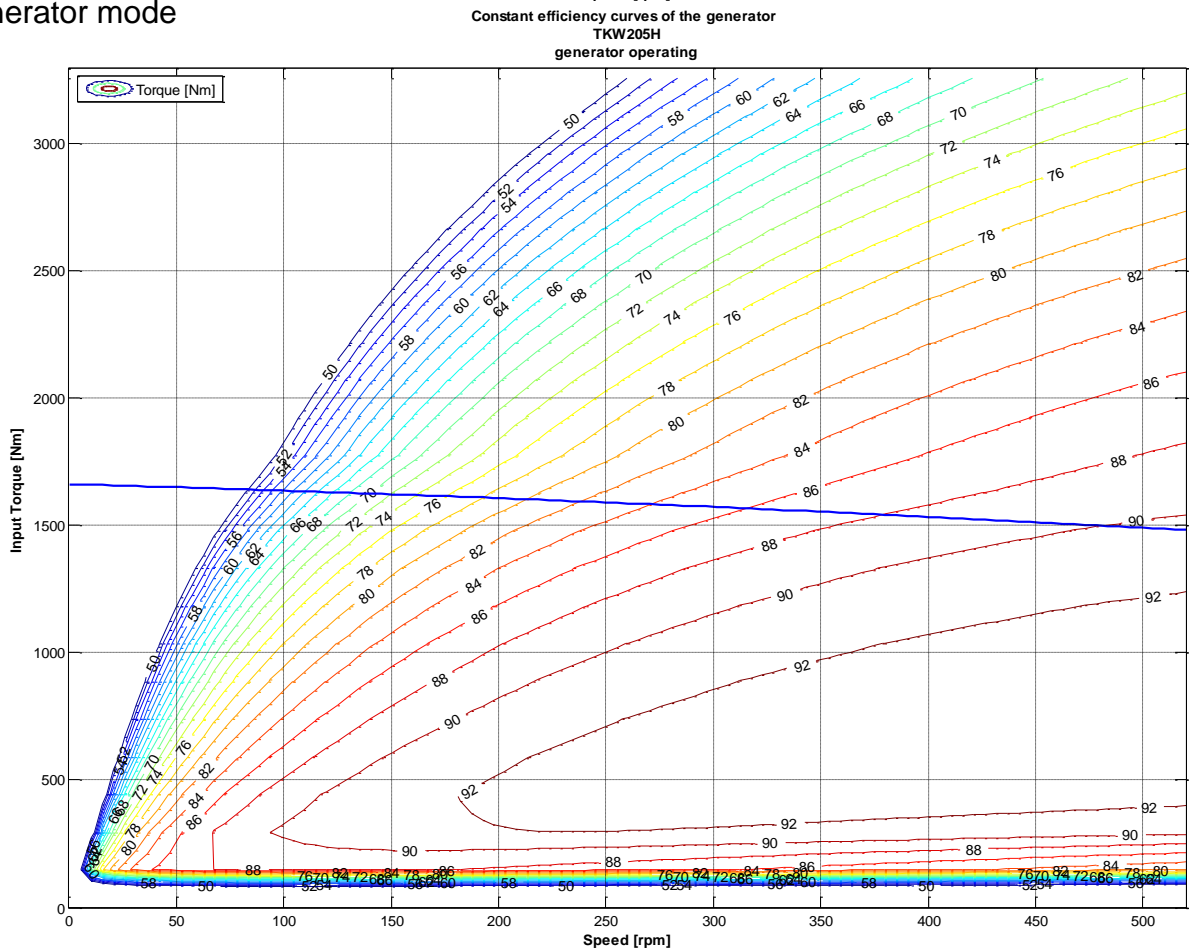



3.2.5.12. TKW206H

Motor mode

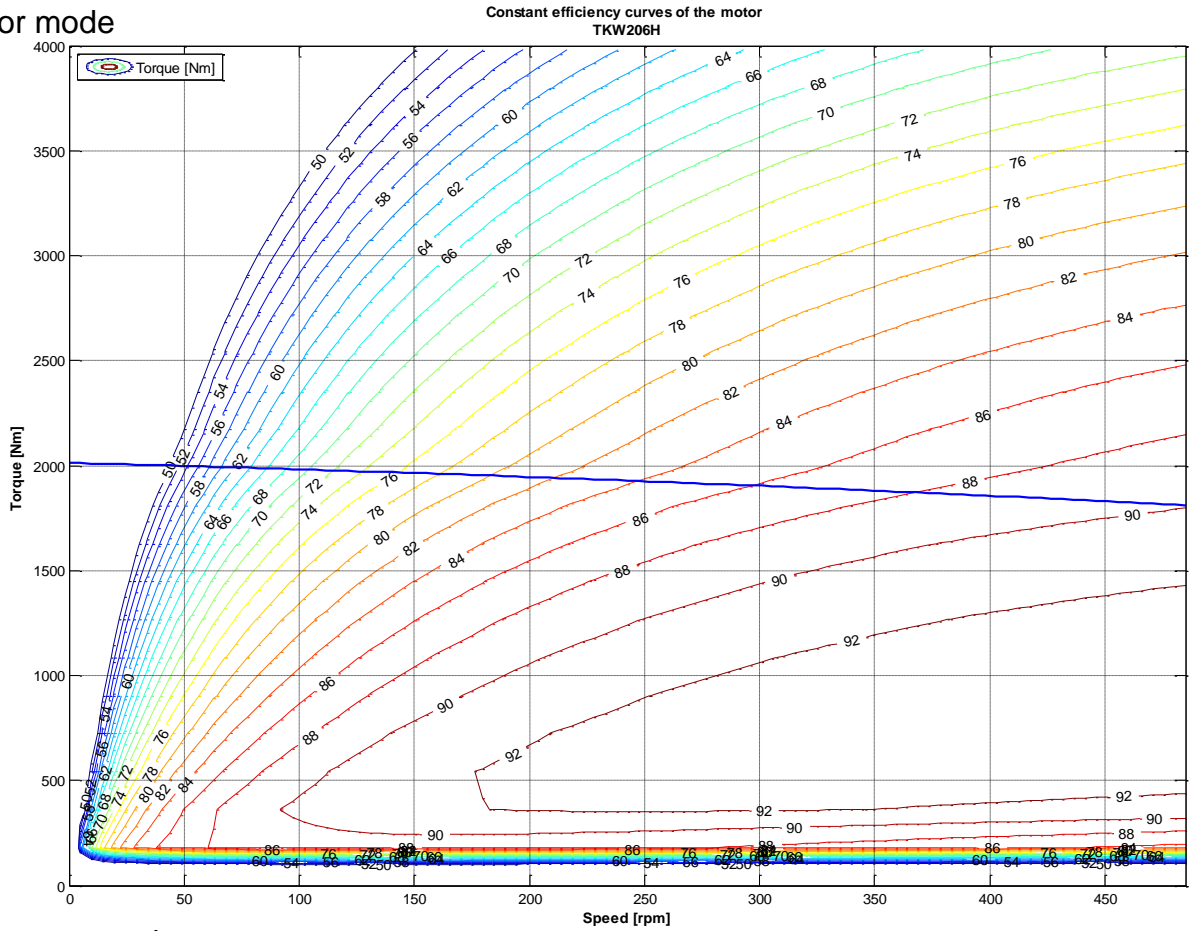

Generator mode

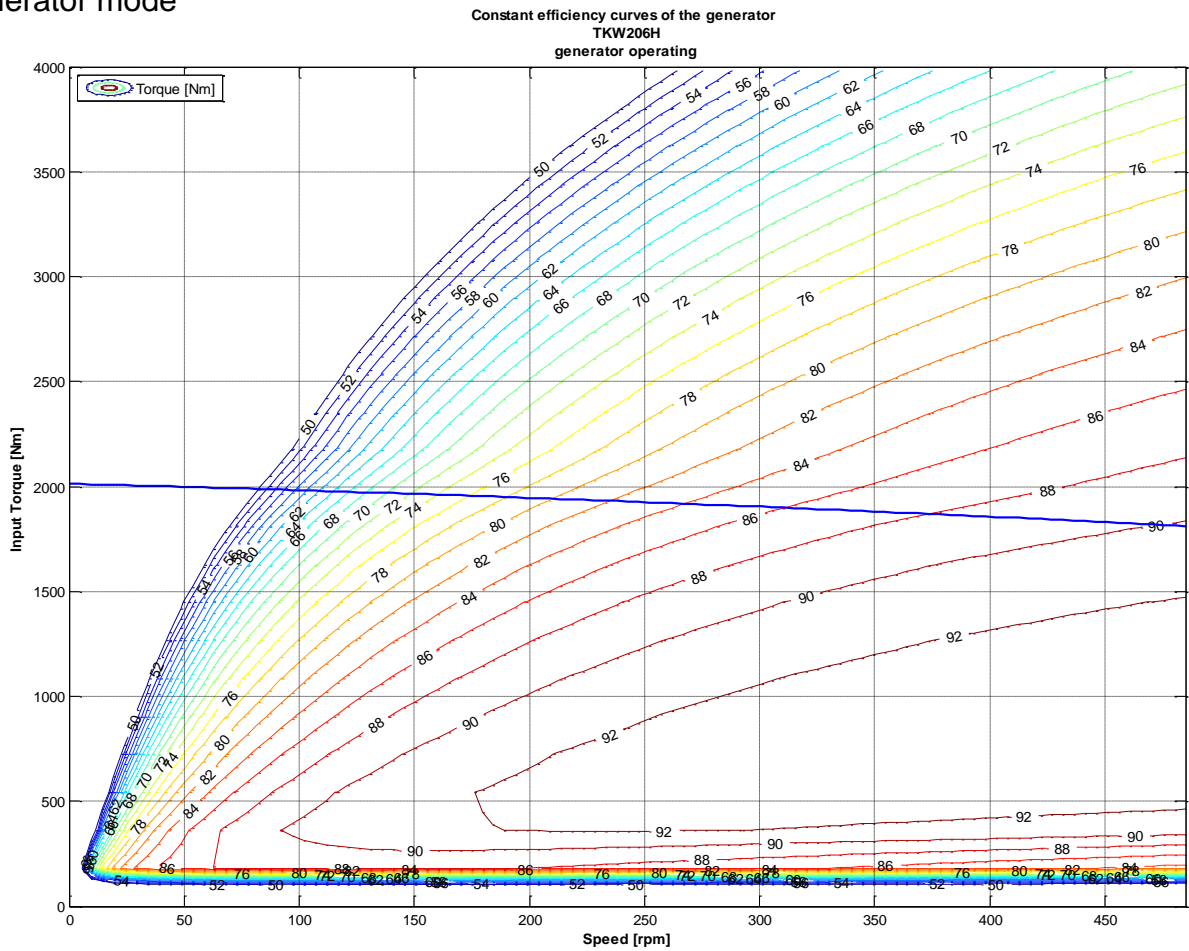



3.2.5.13. TKW208H

Motor mode

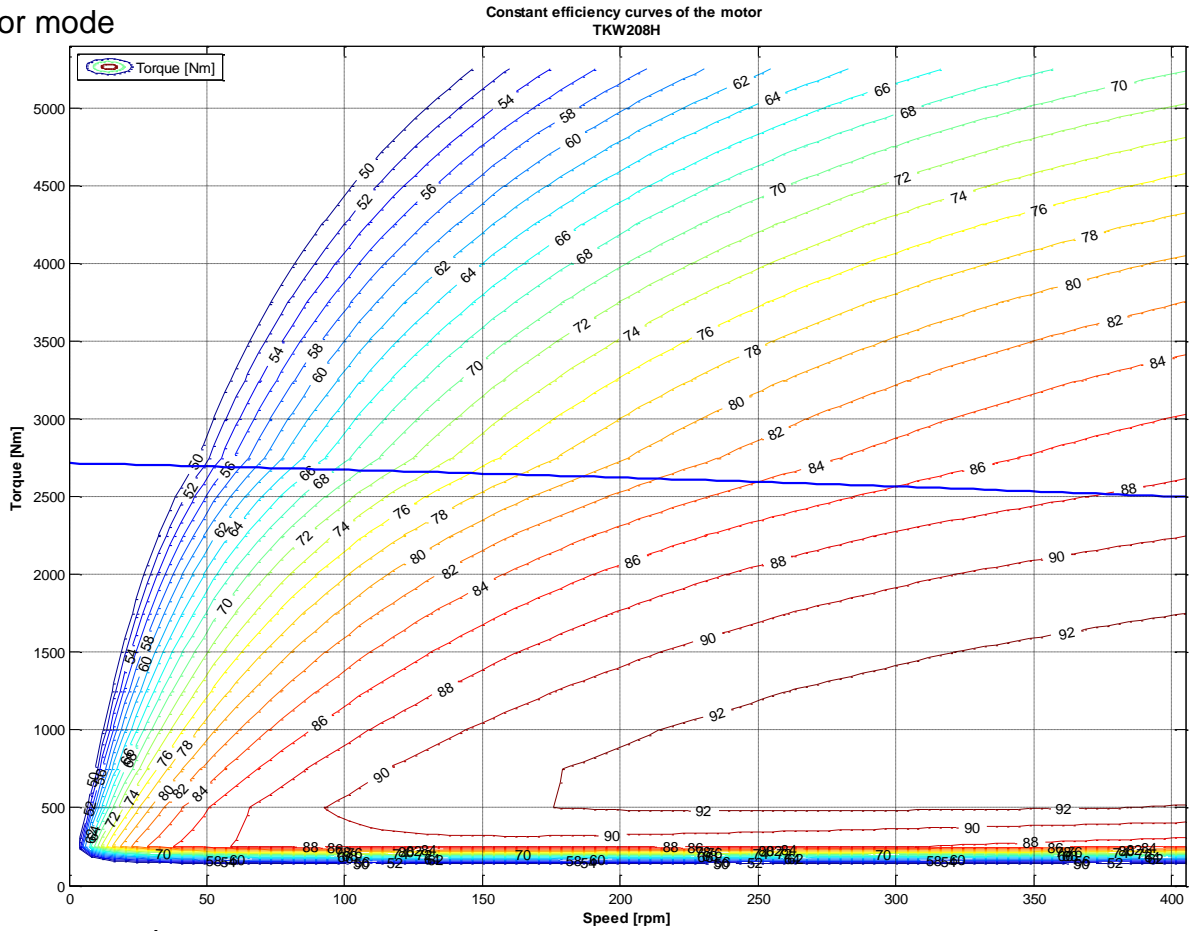

Generator mode

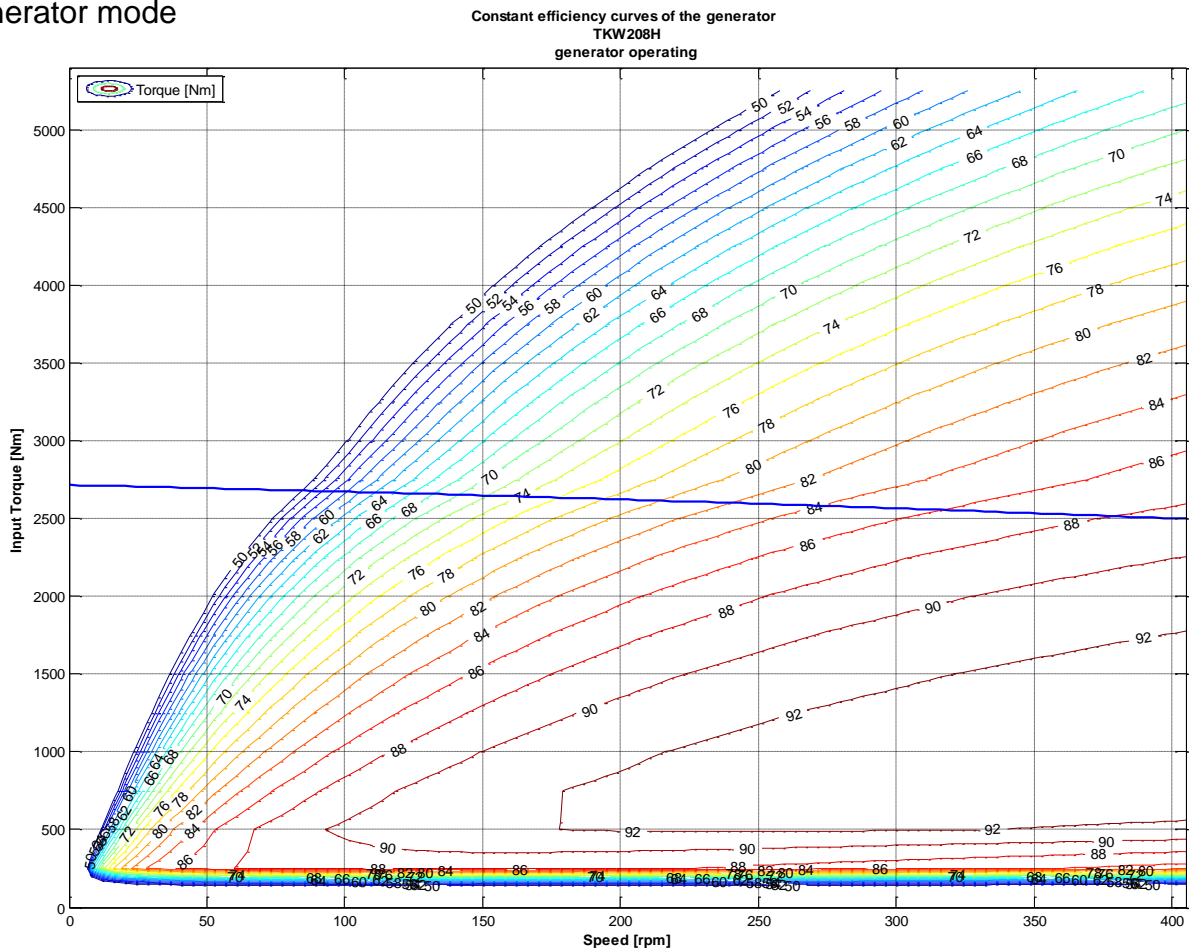



3.2.5.14. TKW301H

Motor mode

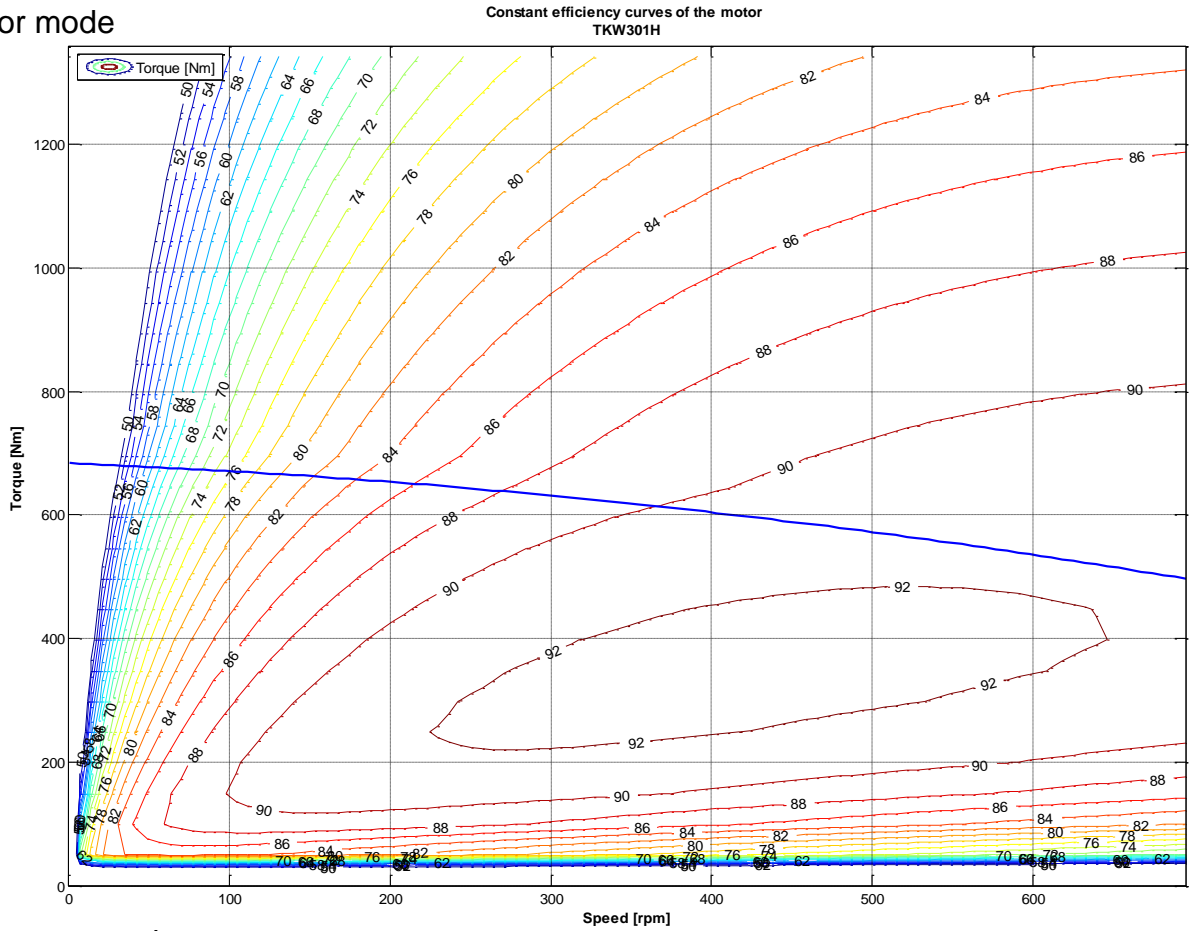

Generator mode

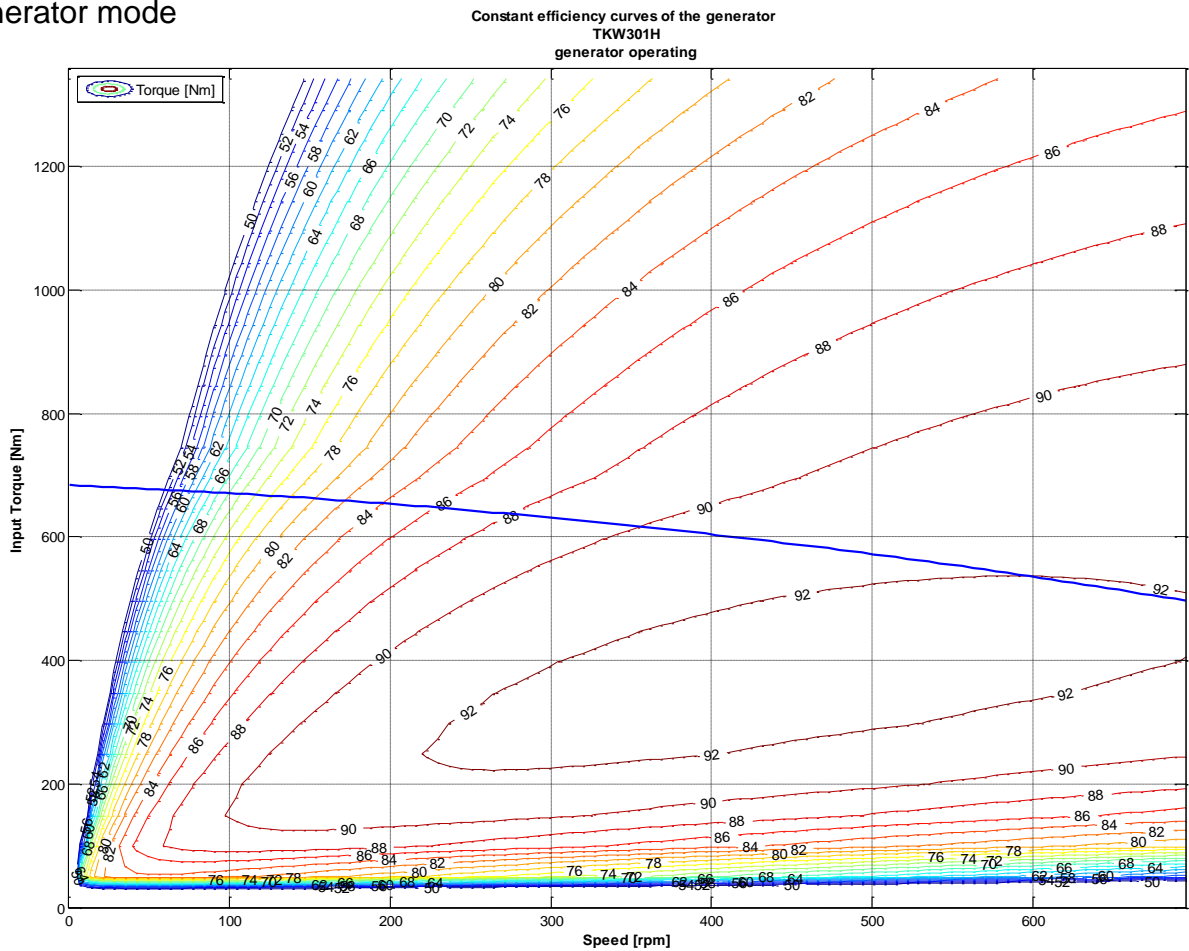



3.2.5.15. TKW302H

Motor mode

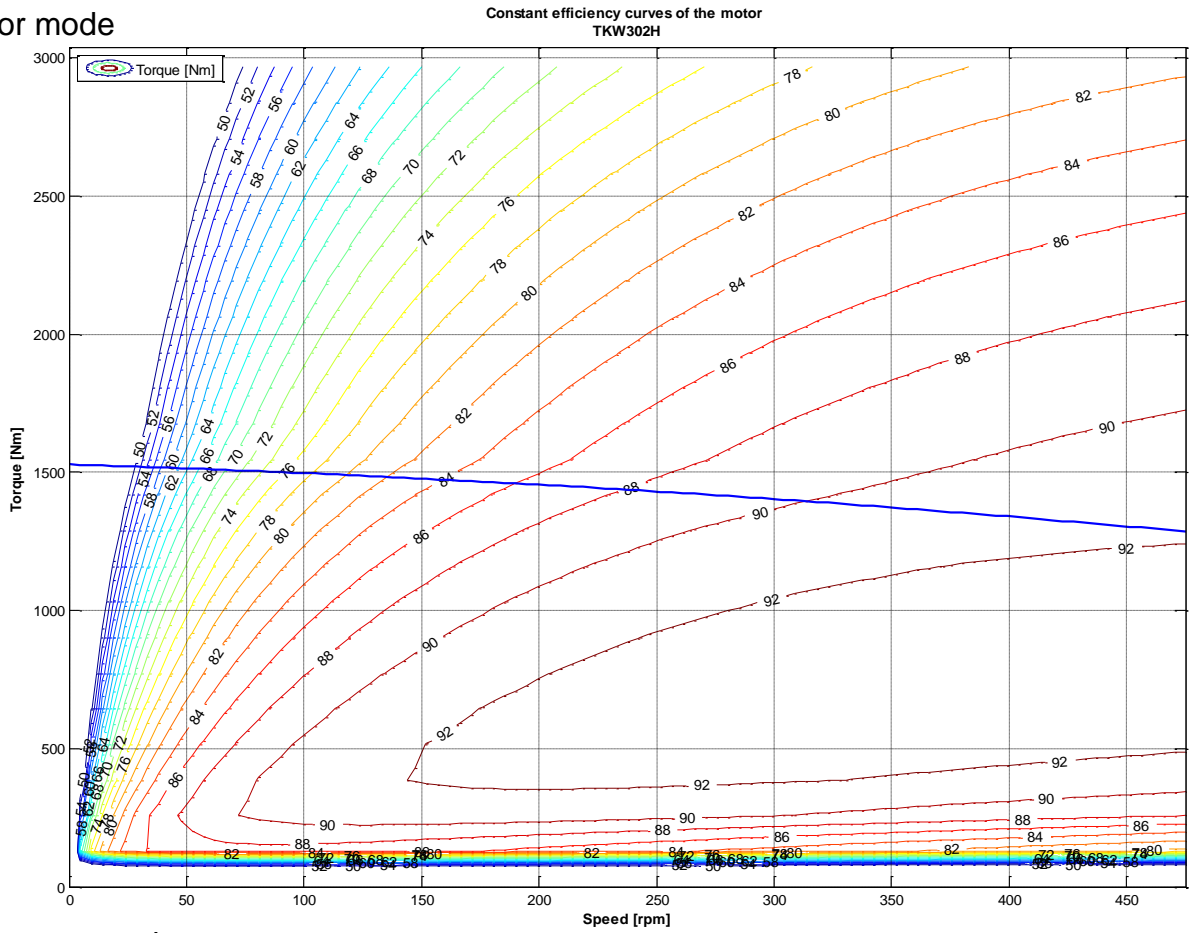

Generator mode

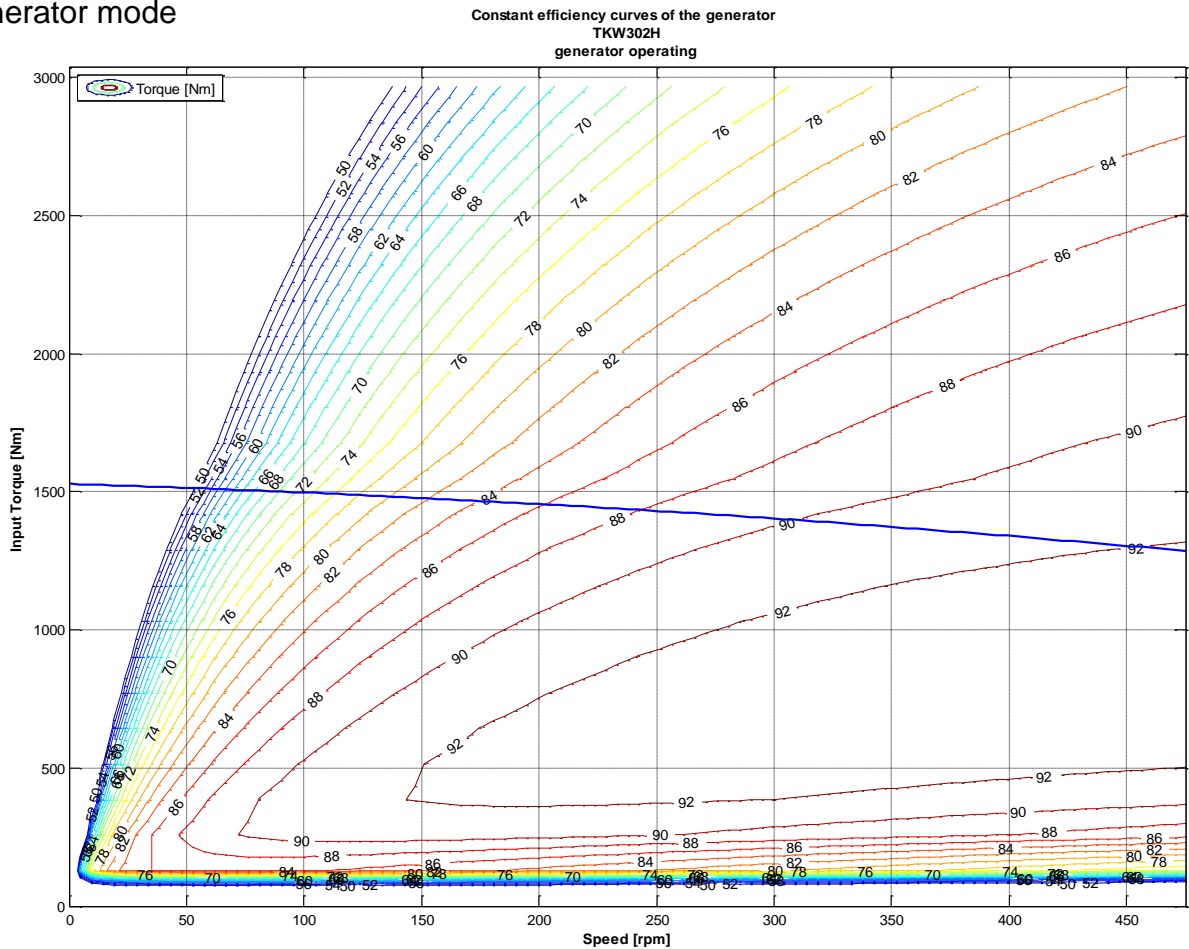



3.2.5.16. TKW303H

Motor mode

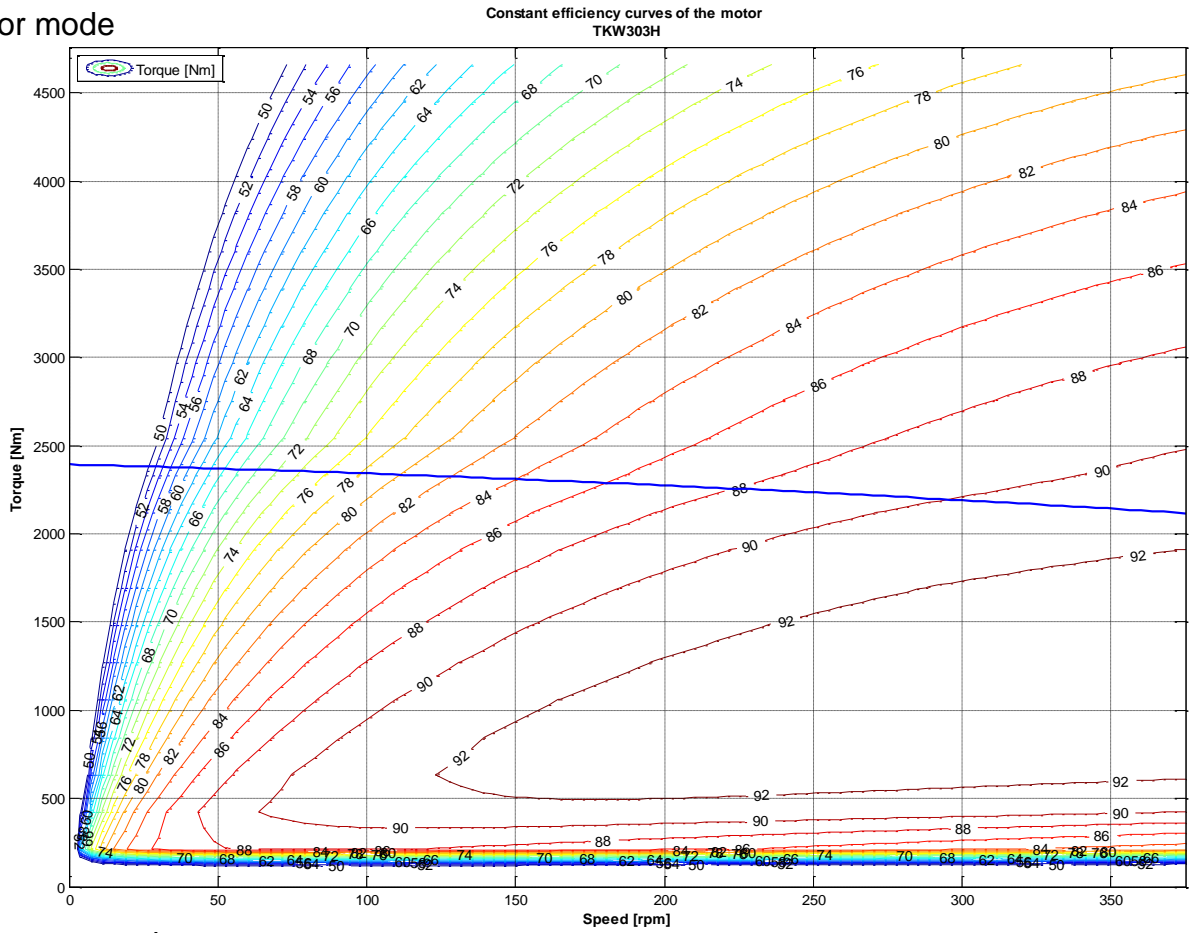

Generator mode

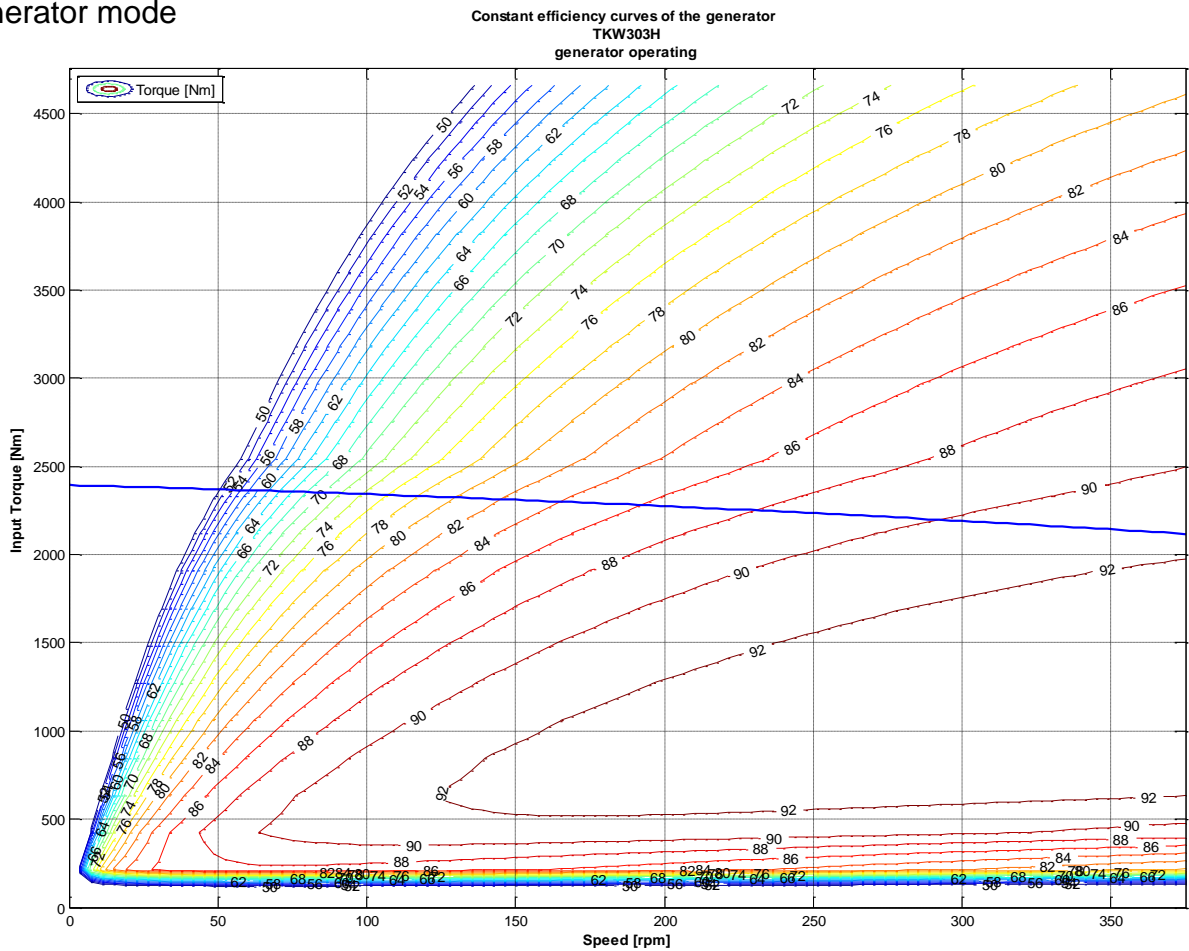



3.2.5.17. TKW304H

Motor mode

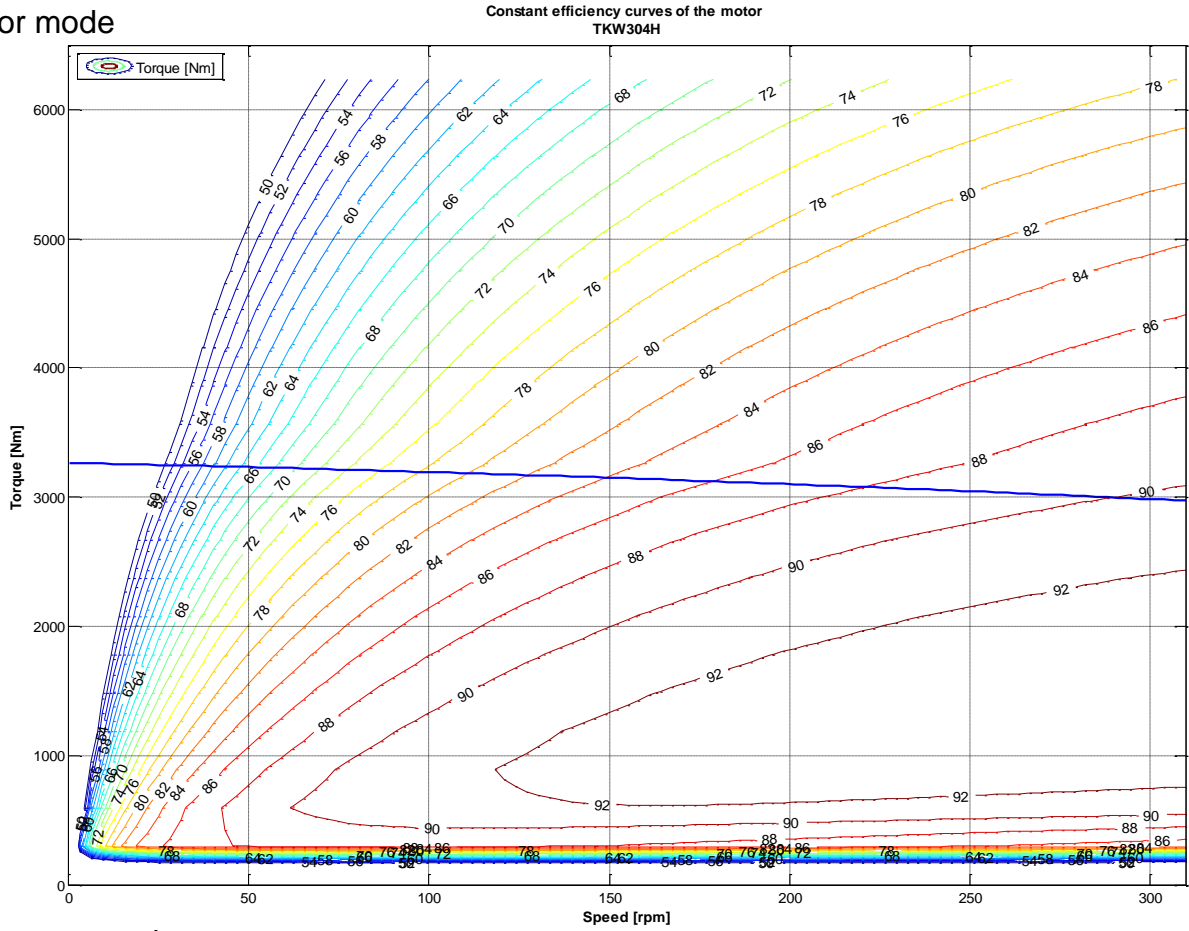

Generator mode

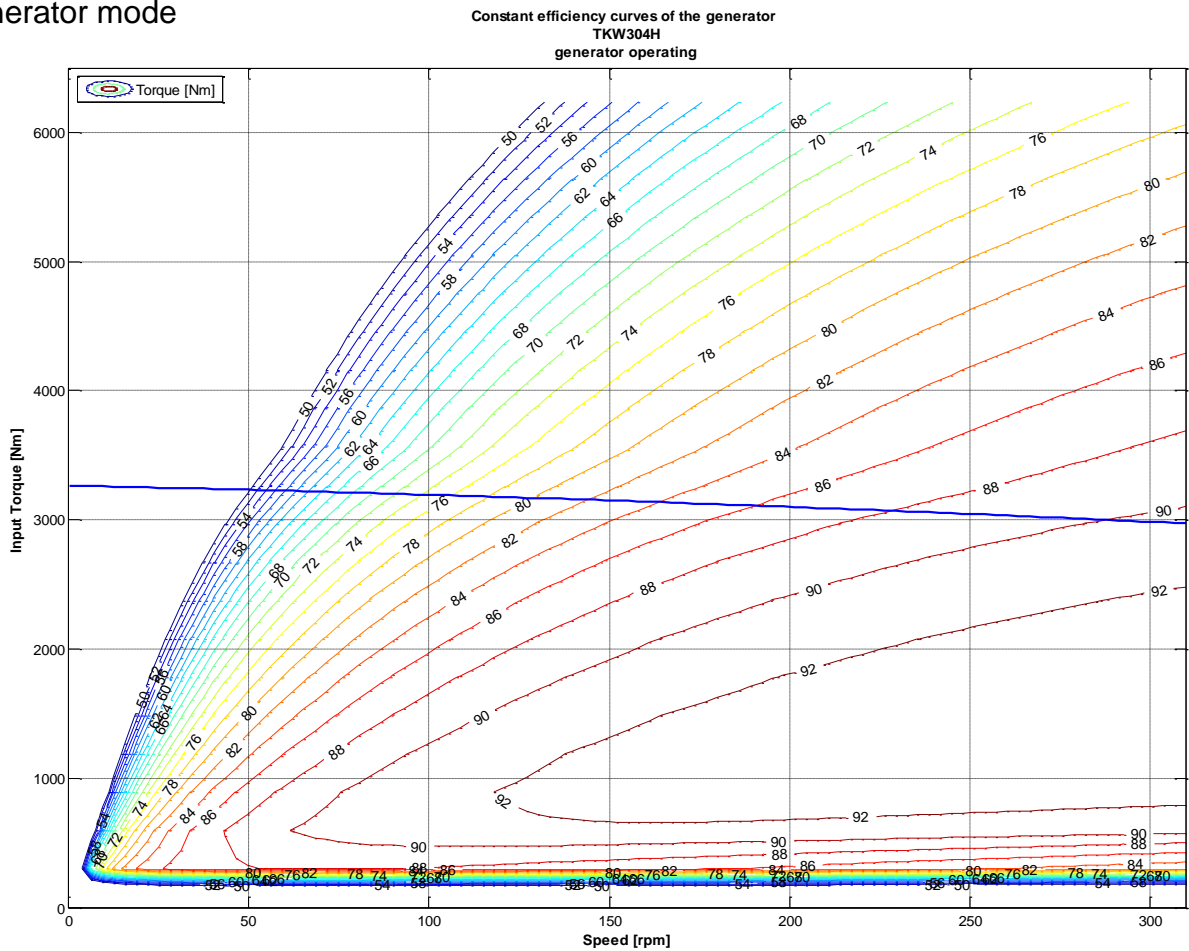



3.2.5.18. TKW305H

Motor mode

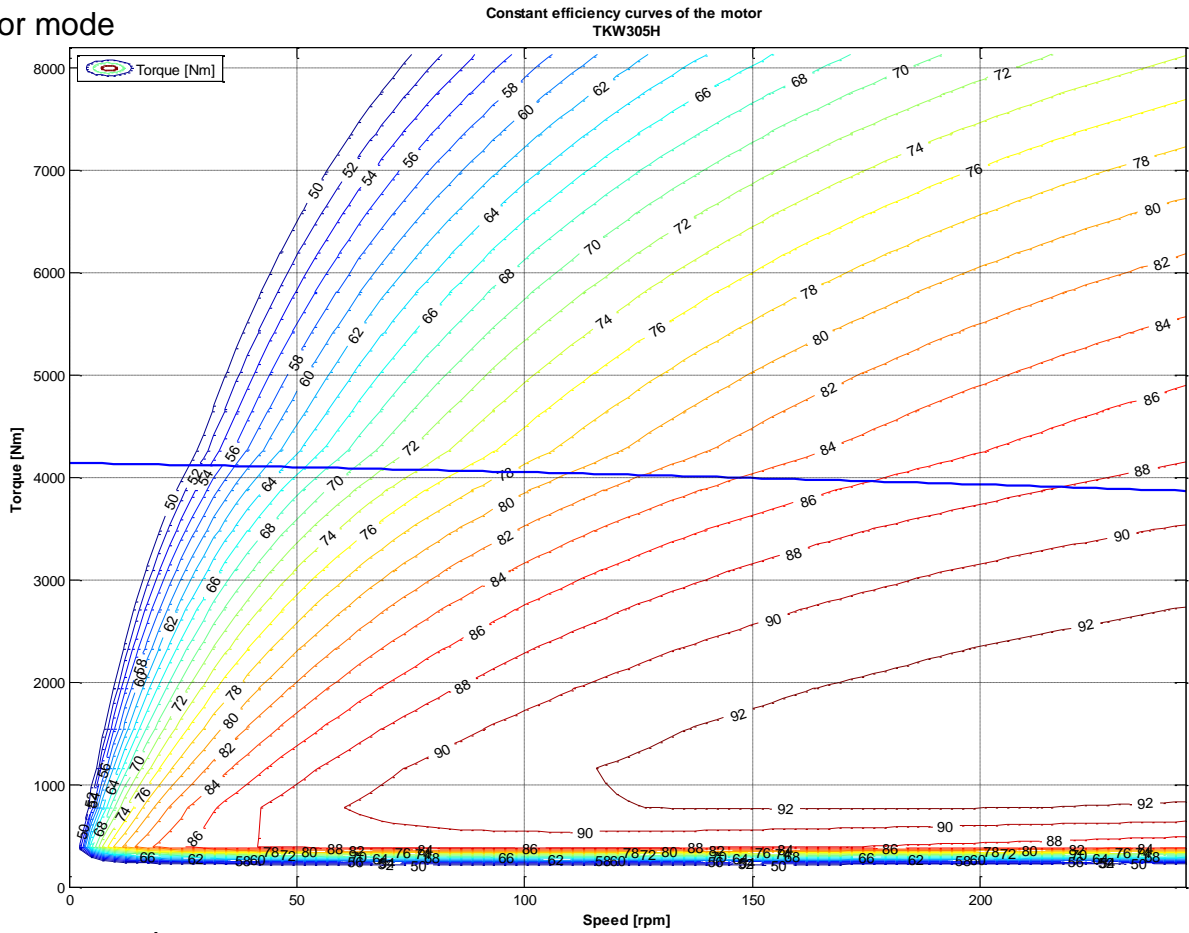

Generator mode

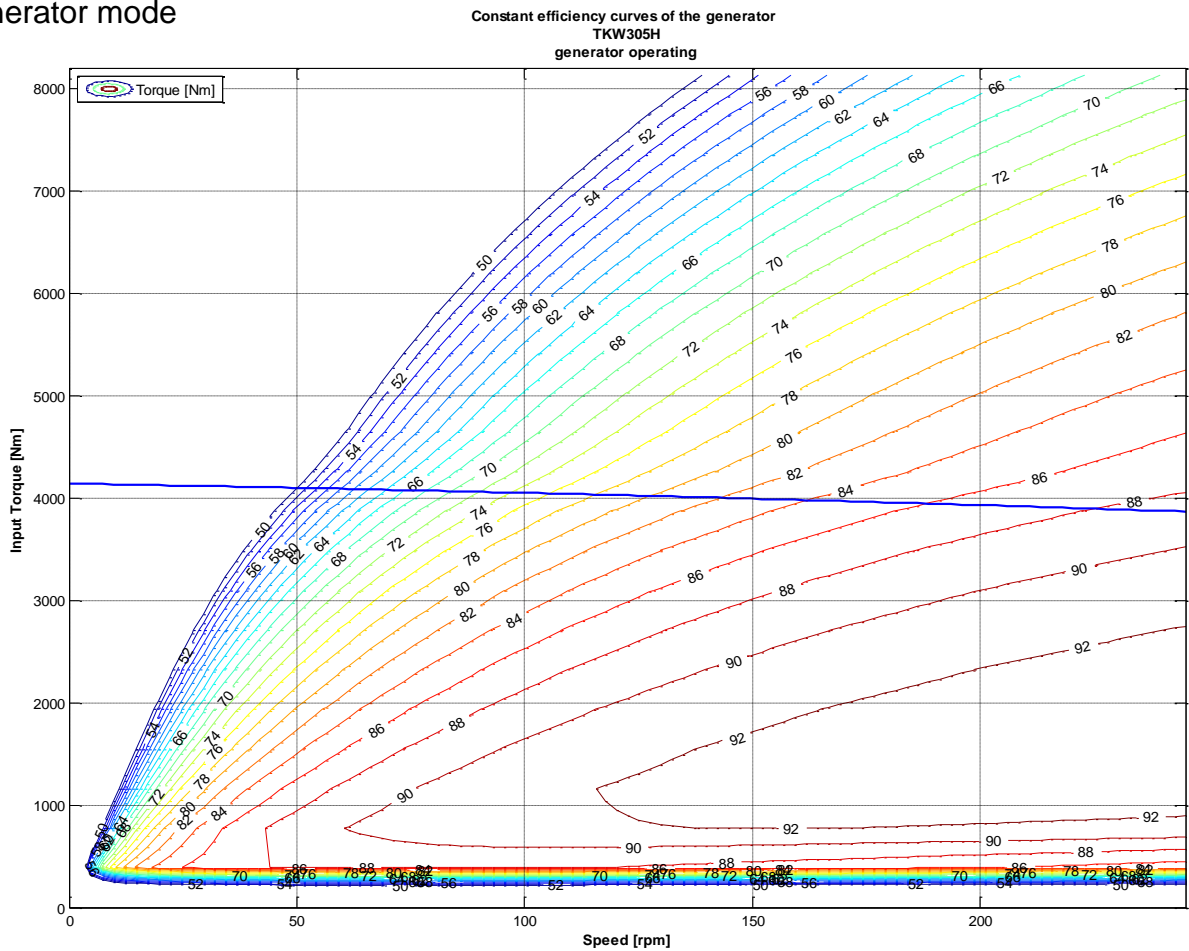



3.2.5.19. TKW306H

Motor mode

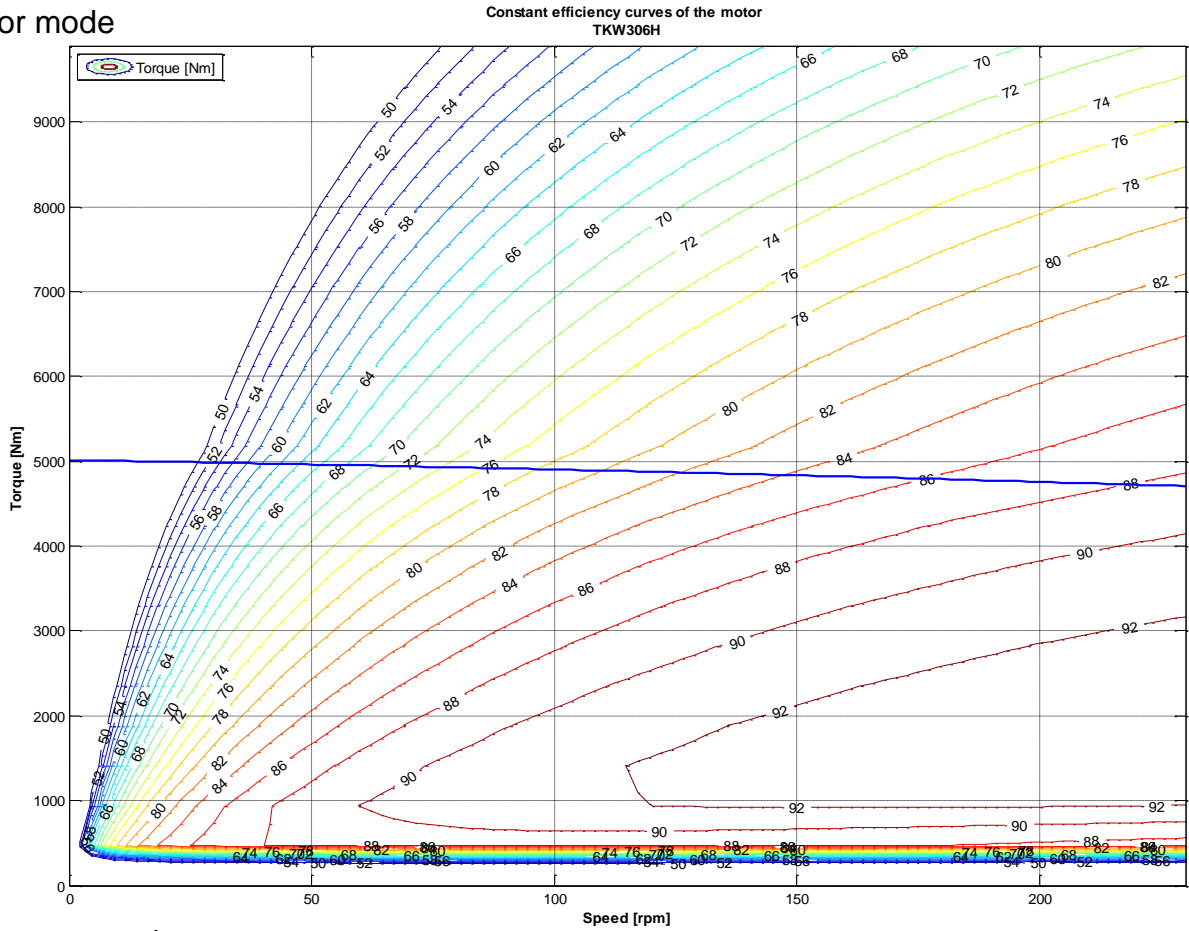

Generator mode

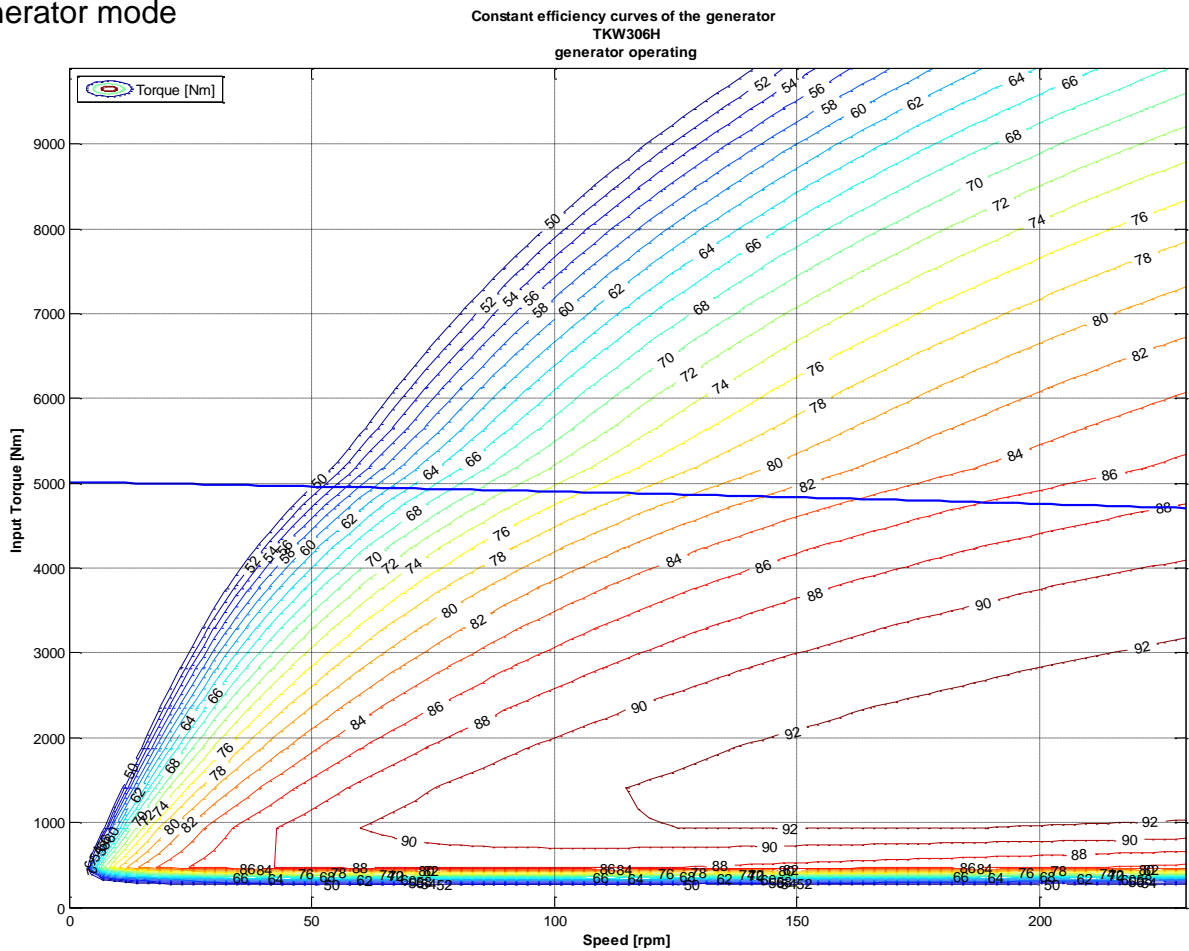



3.2.5.20. TKW308H

Motor mode

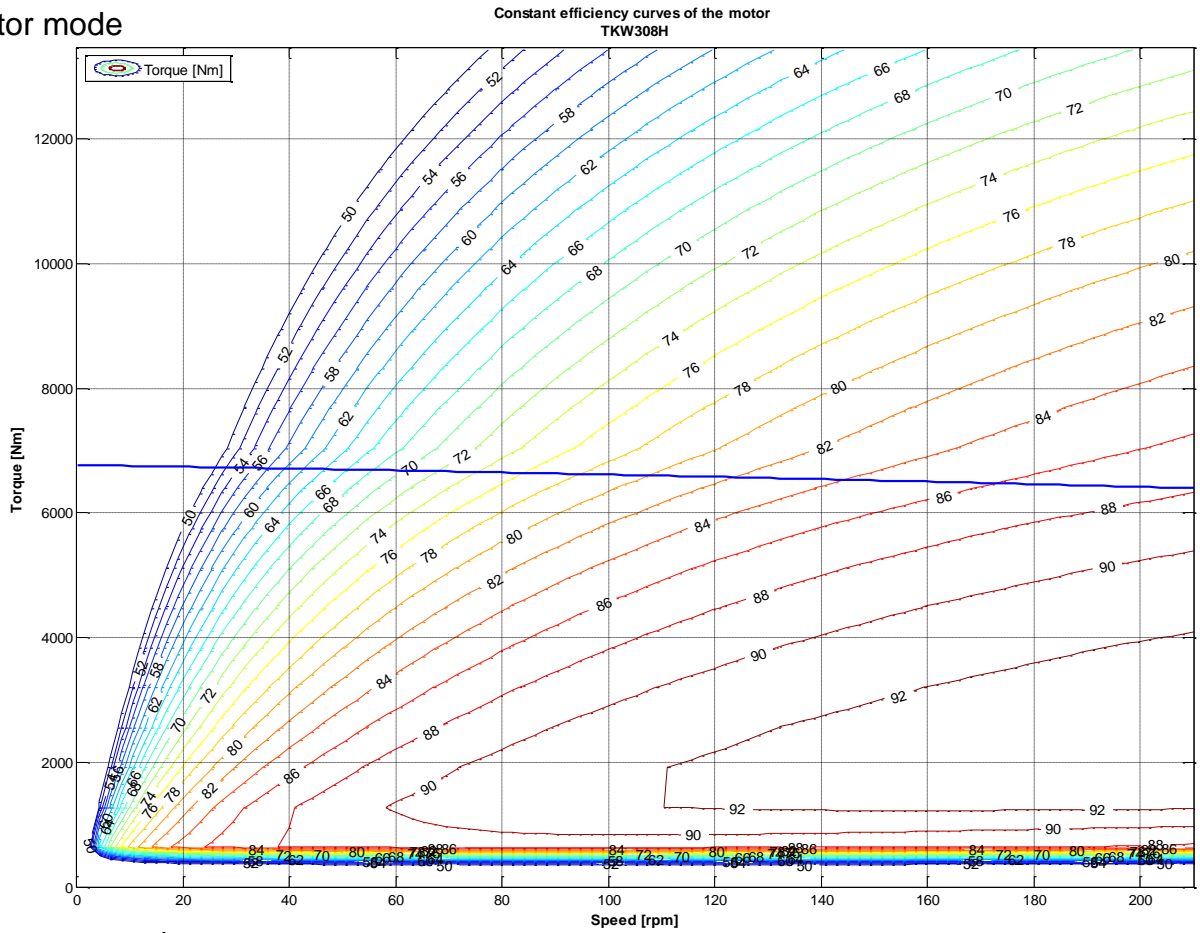

Generator mode

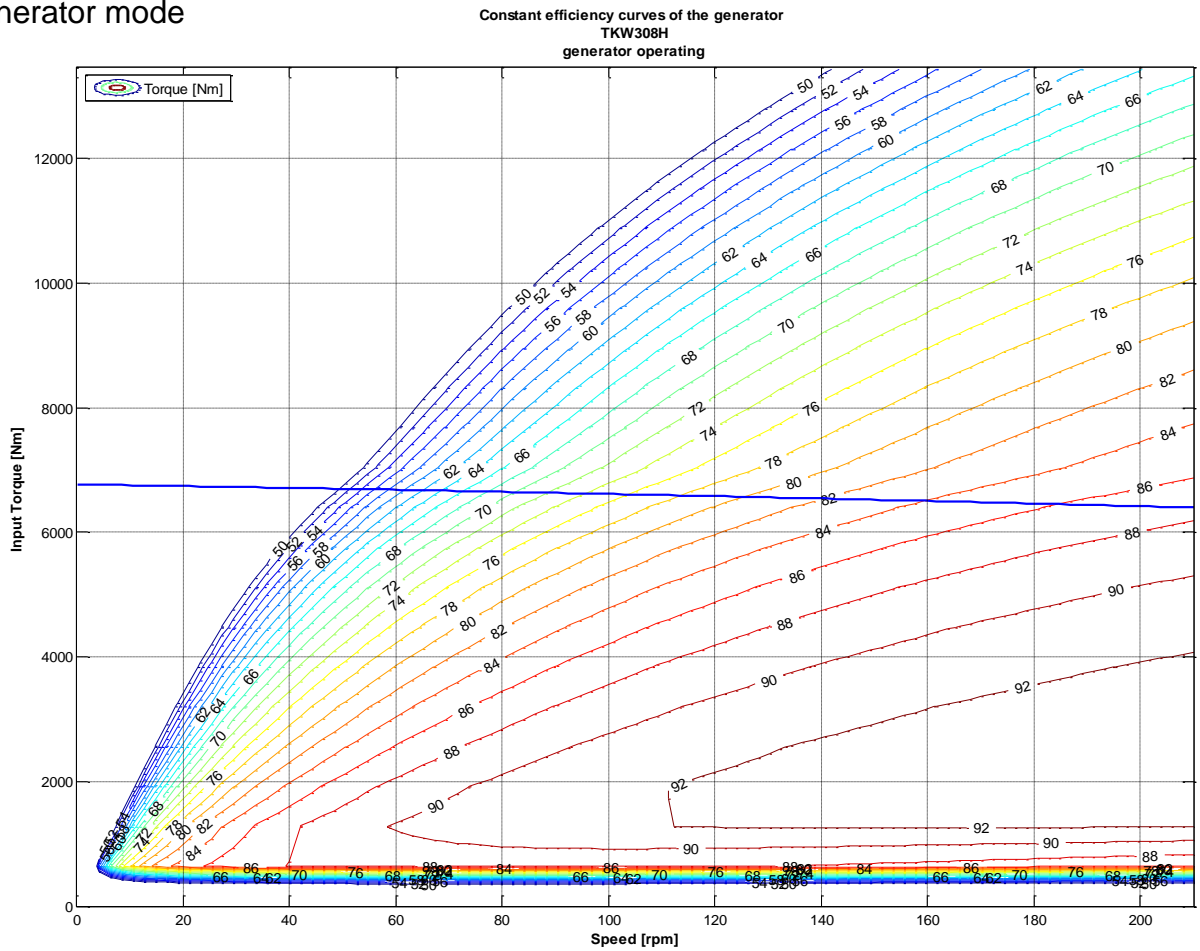



3.2.5.21. TKW30AH

Motor mode

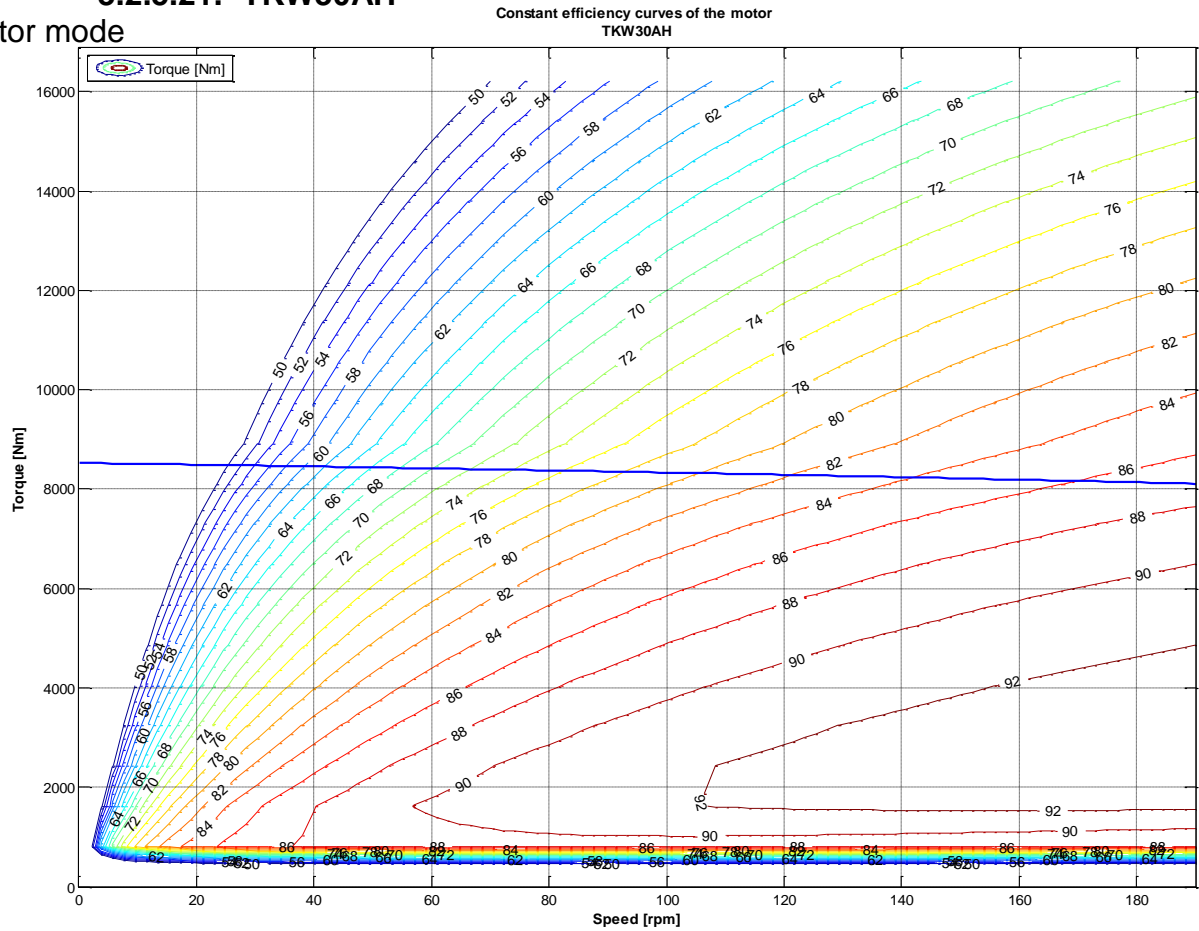

Generator mode

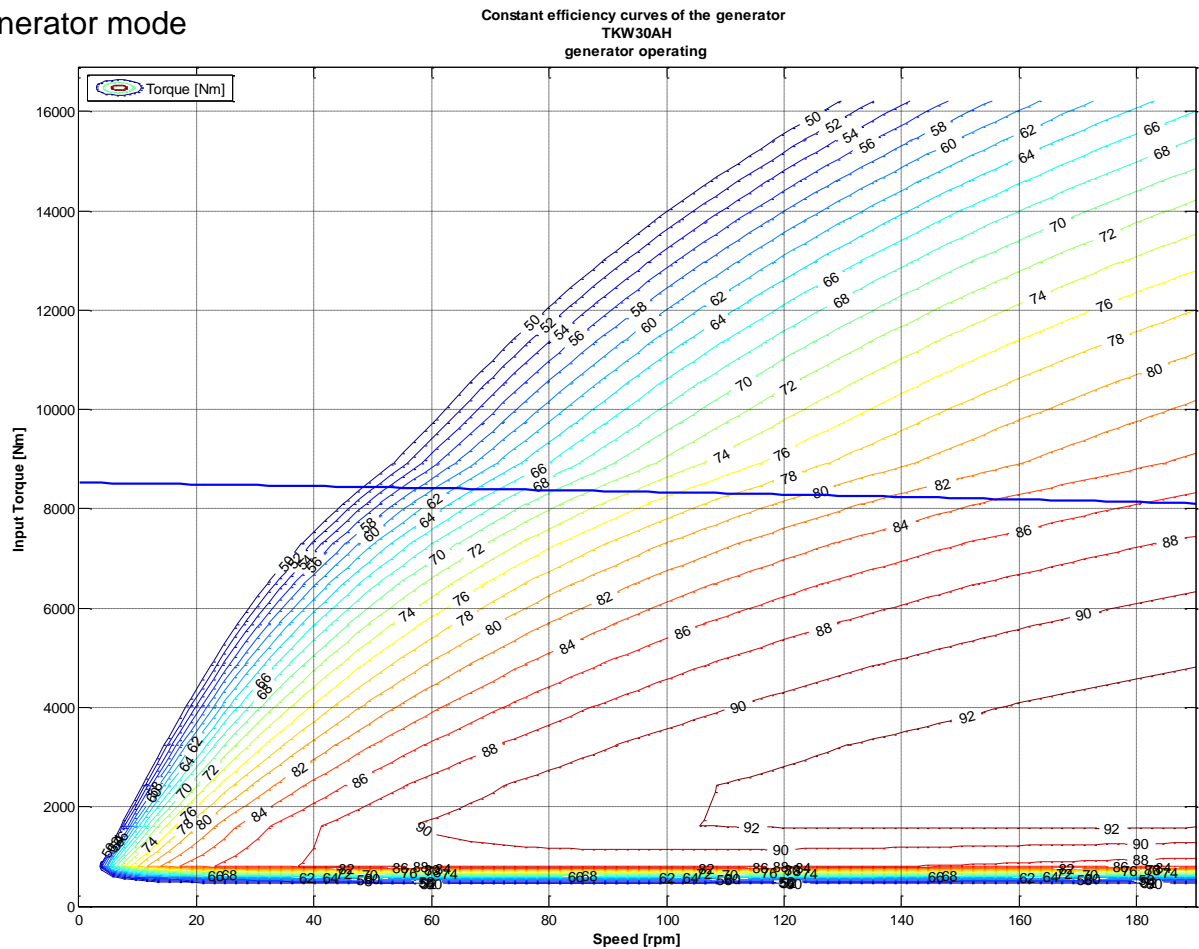



3.2.5.22. TKW401H

Motor mode

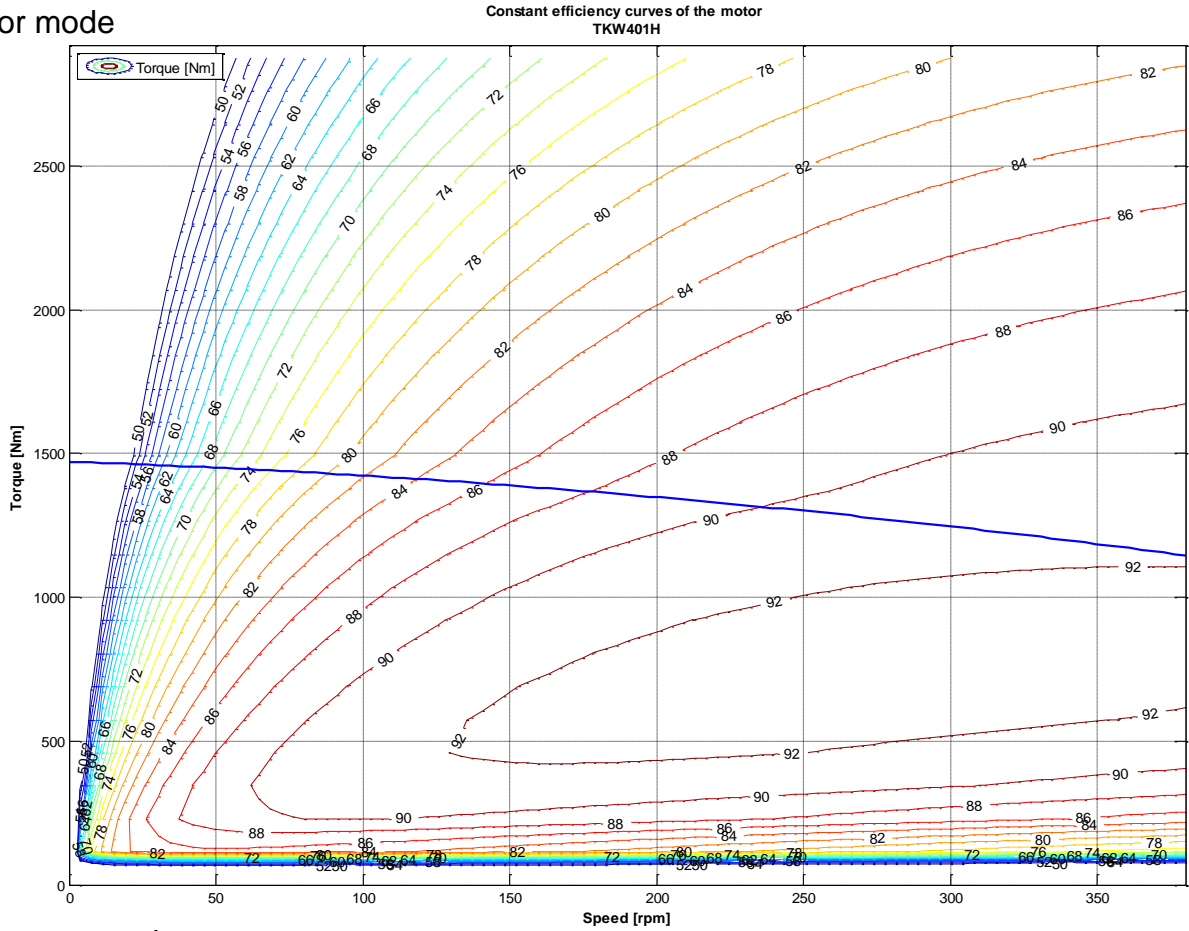

Generator mode

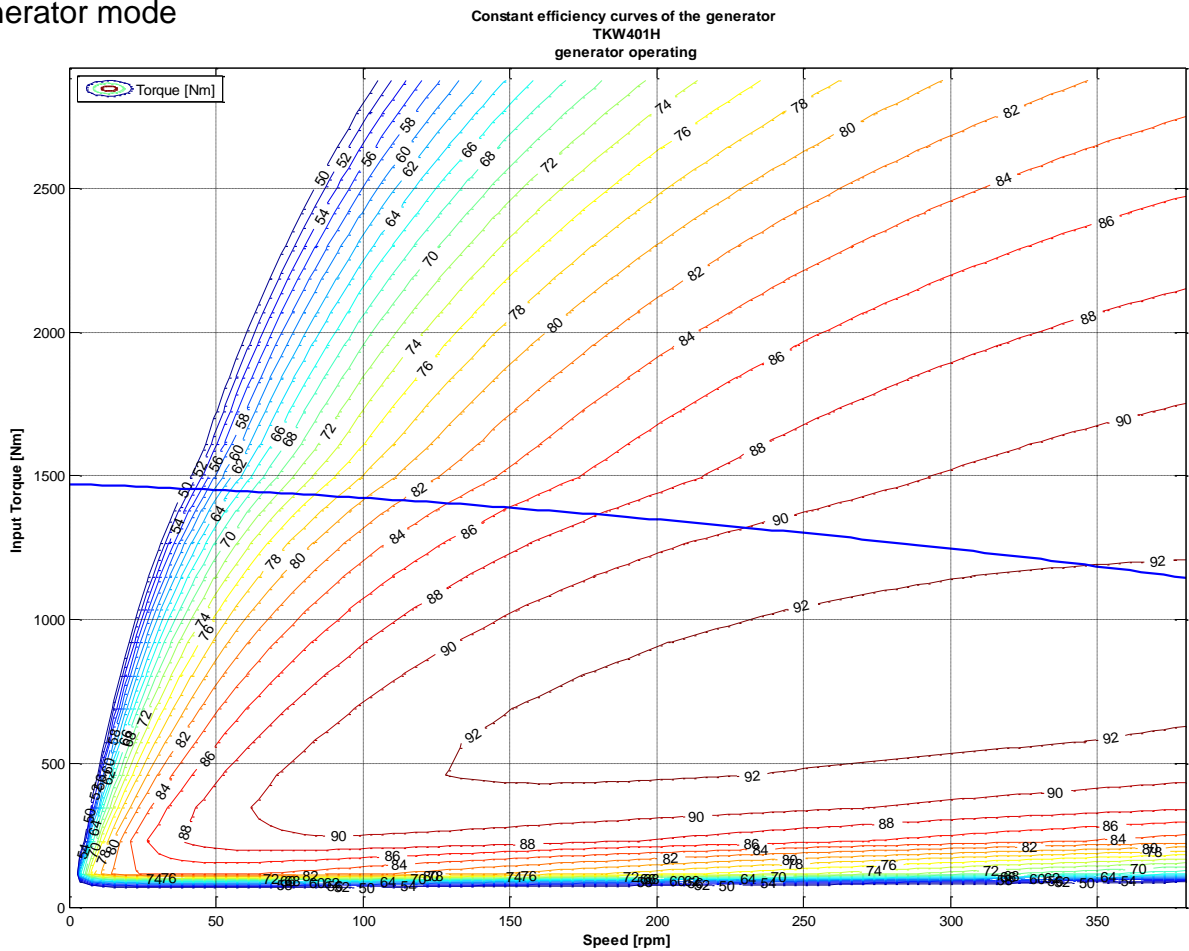

3.2.5.23. TKW402H

Motor mode

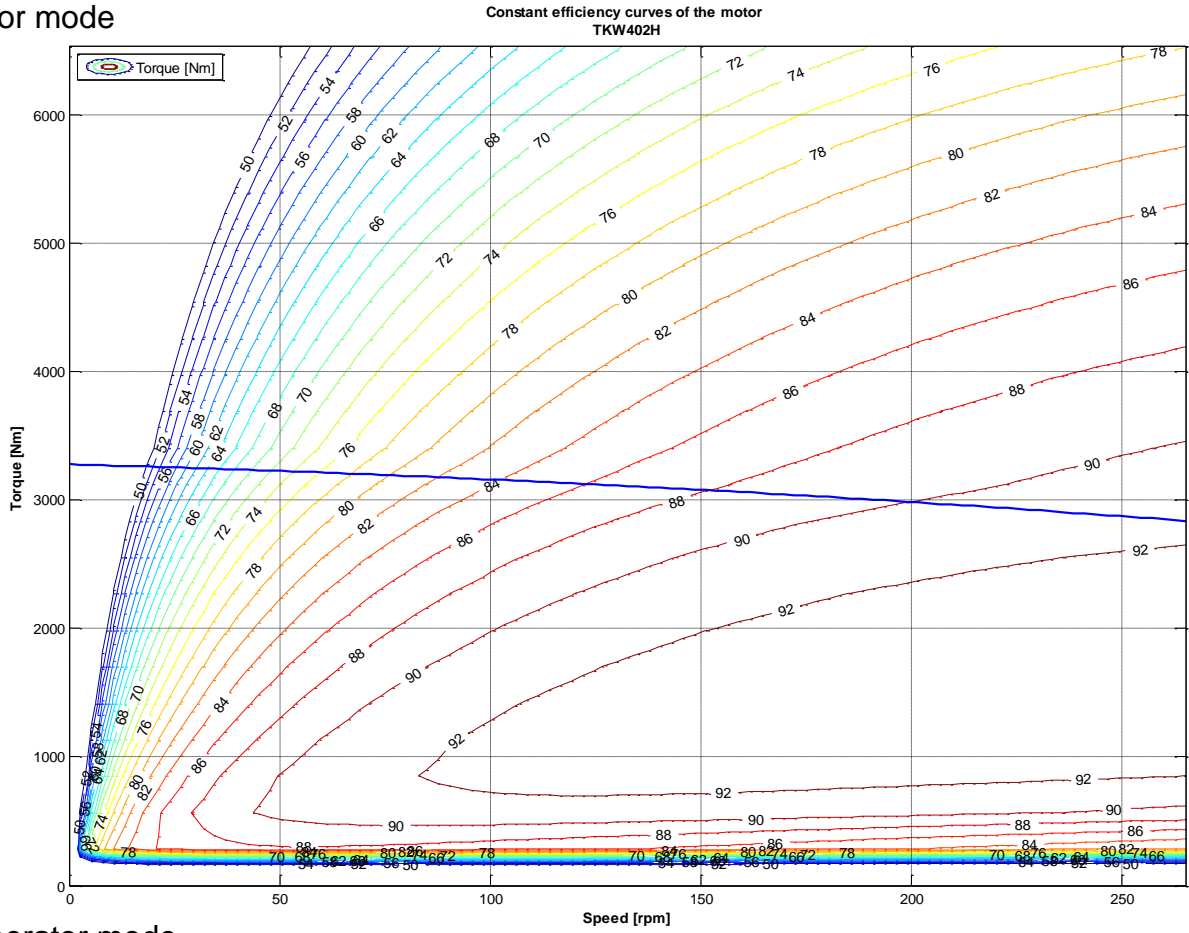

Generator mode

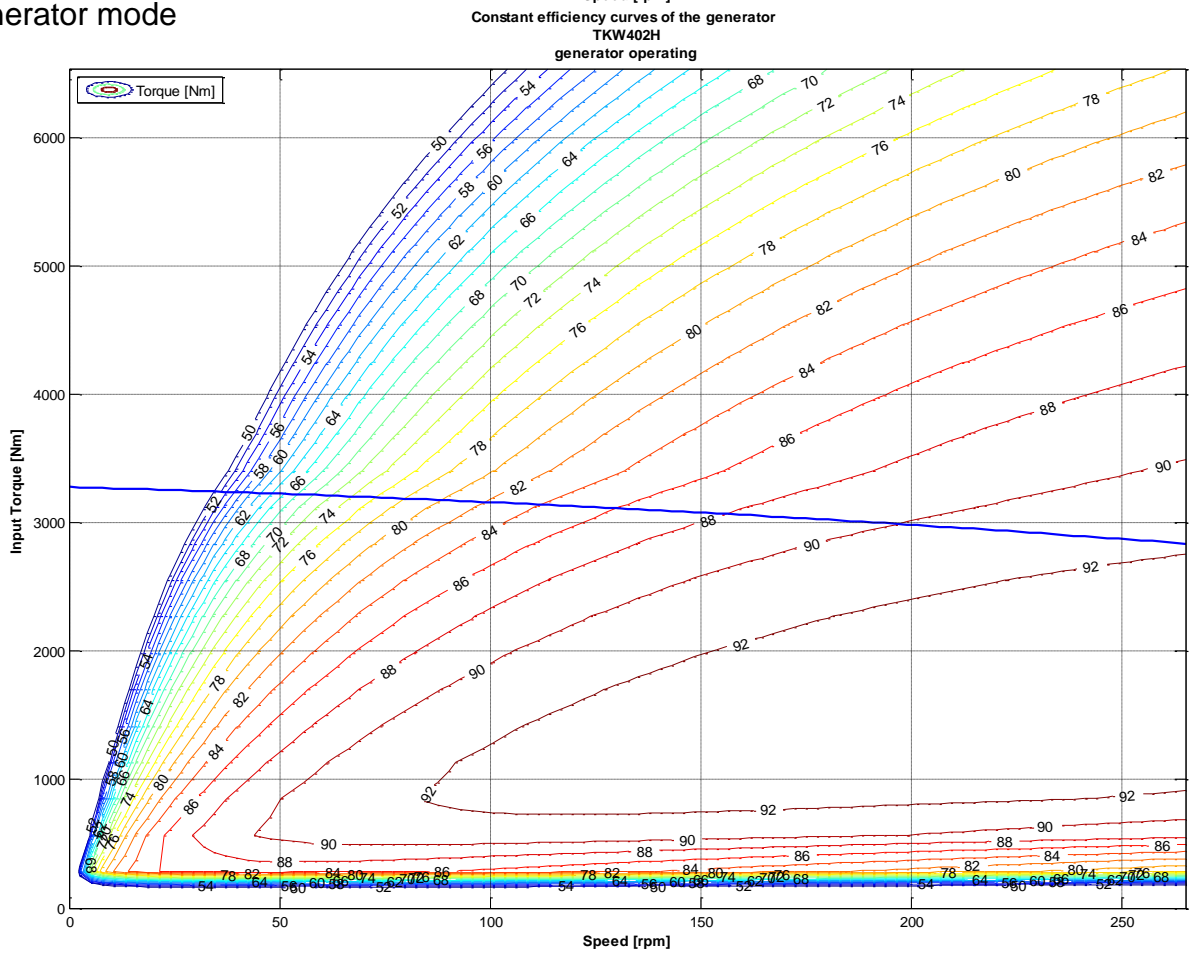



3.2.5.24. TKW403H

Motor mode

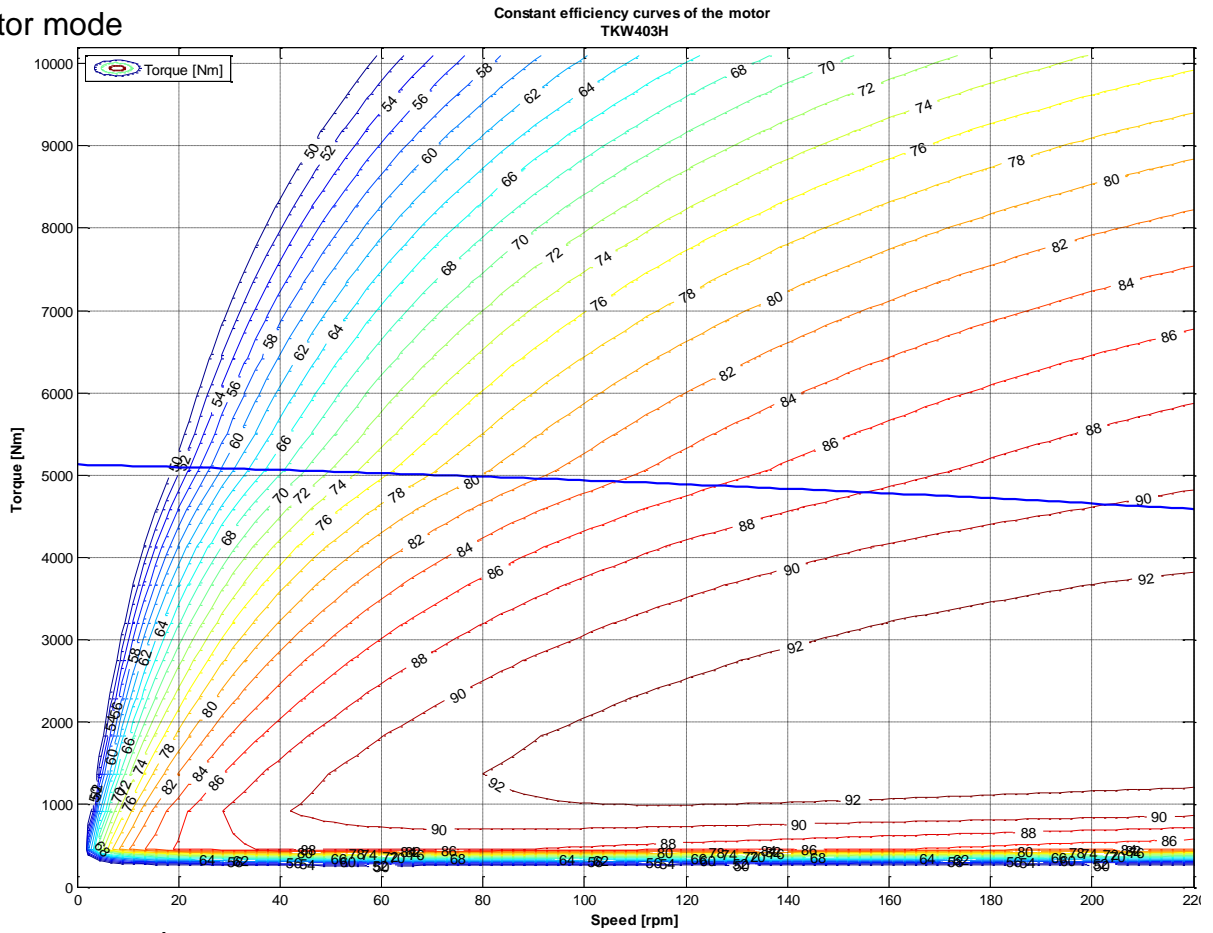

Generator mode

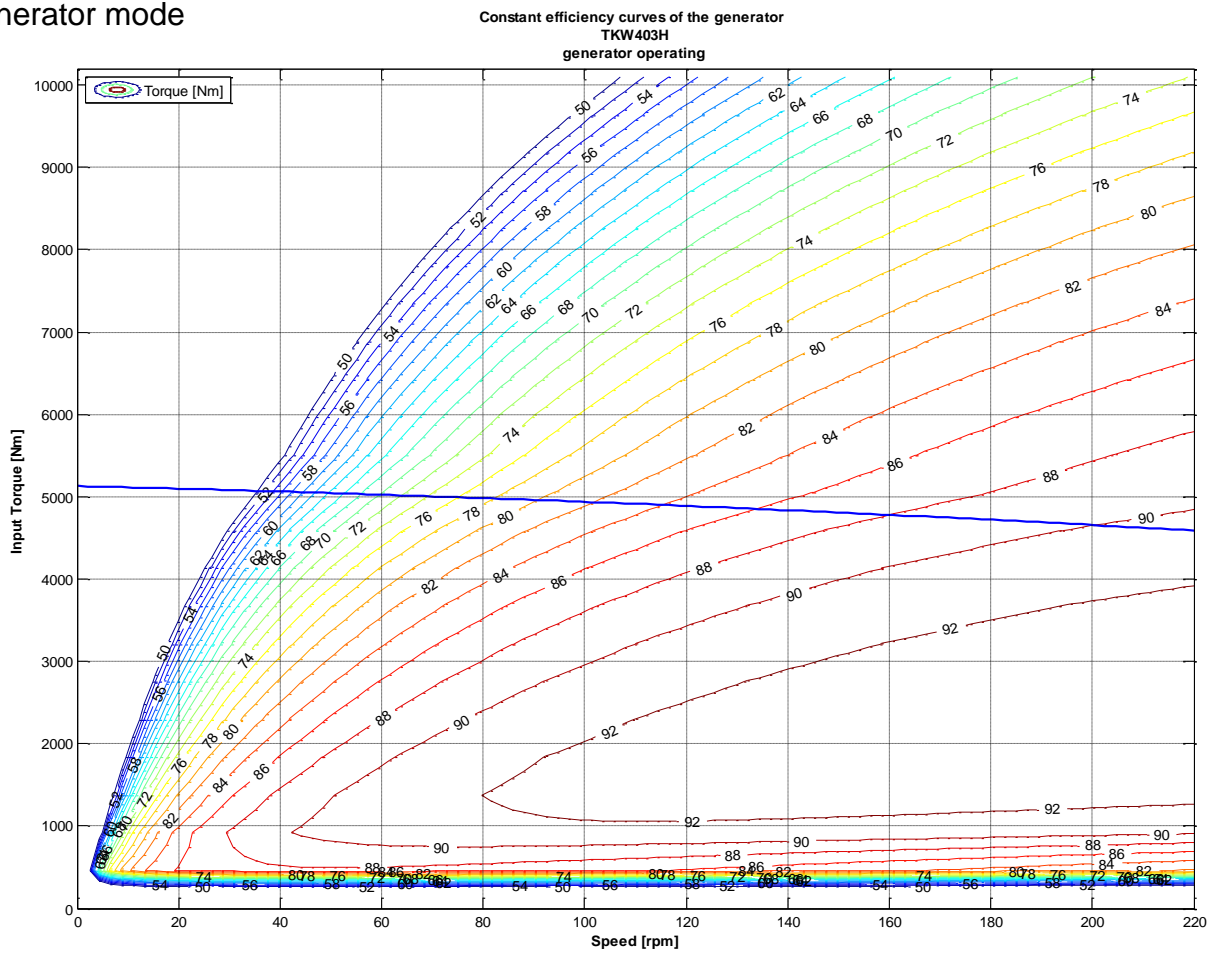



3.2.5.25. TKW404H

Motor mode

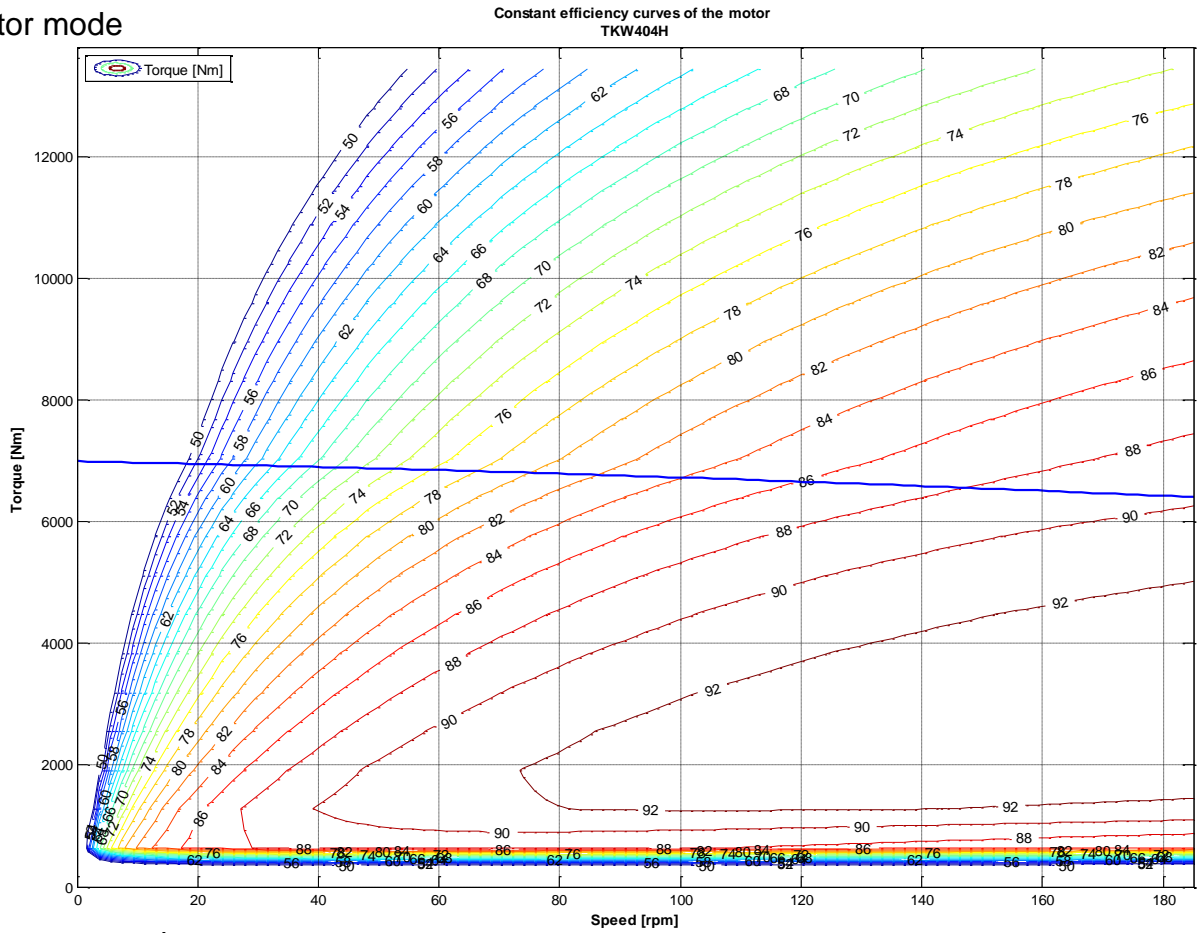

Generator mode

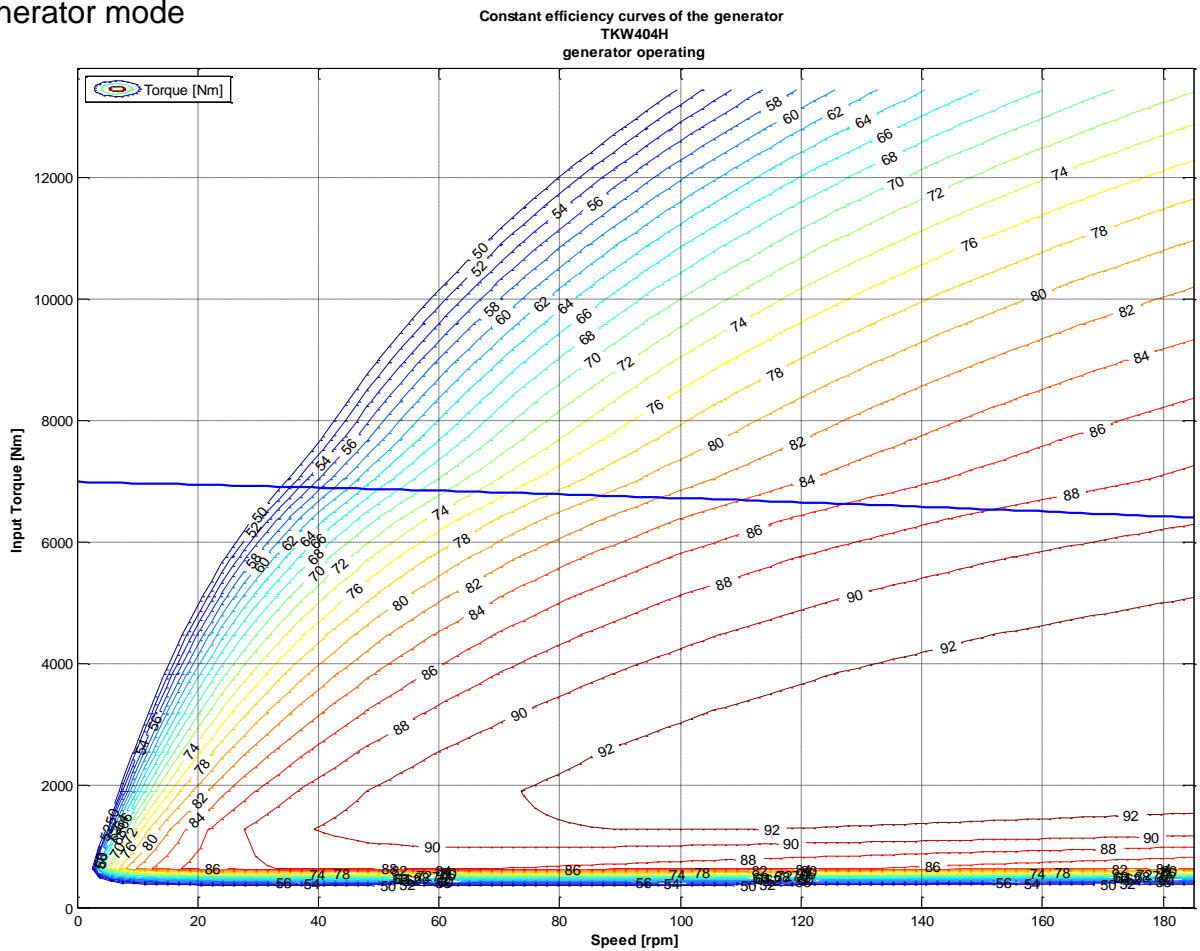



3.2.5.26. TKW406H

Motor mode

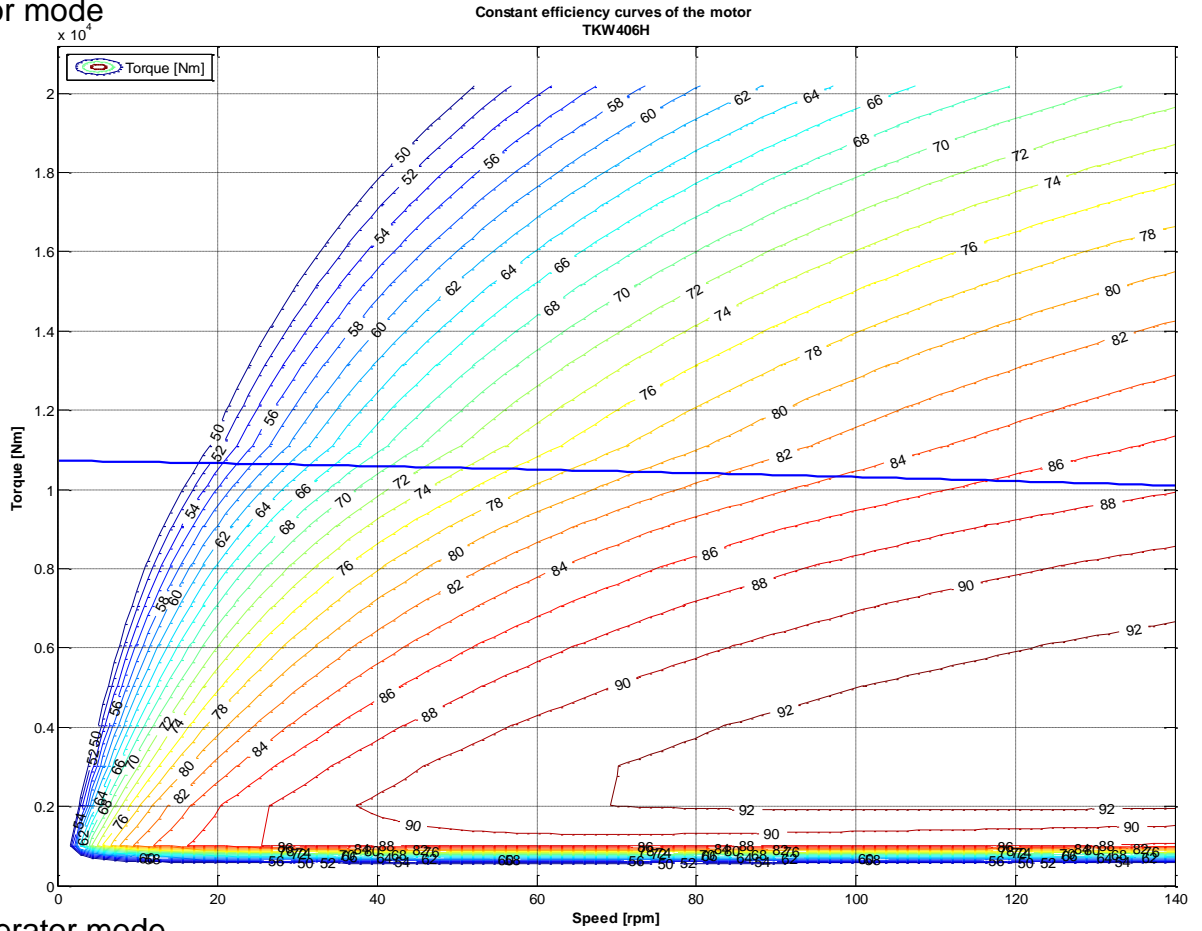

Generator mode

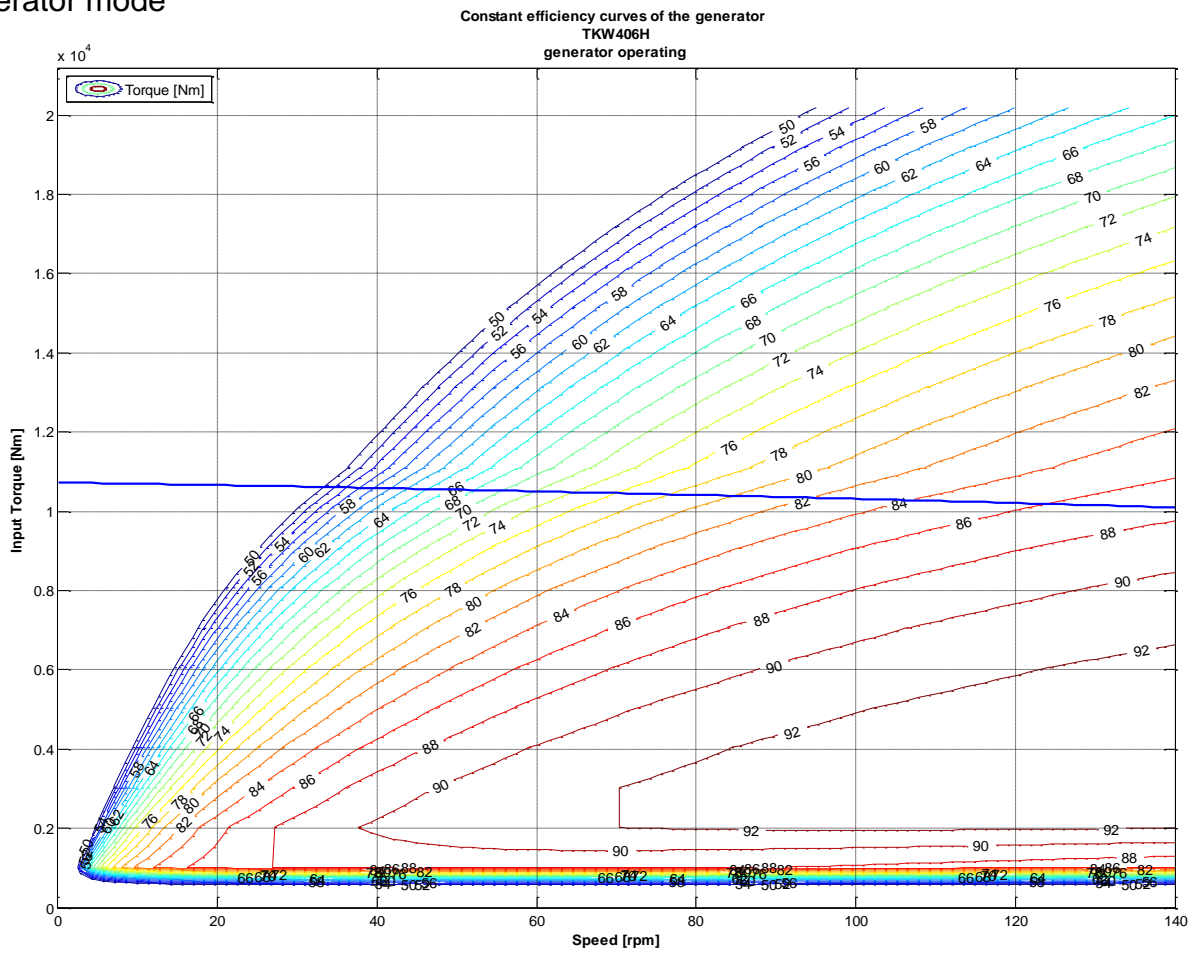



3.2.5.27. TKW408H

Motor mode

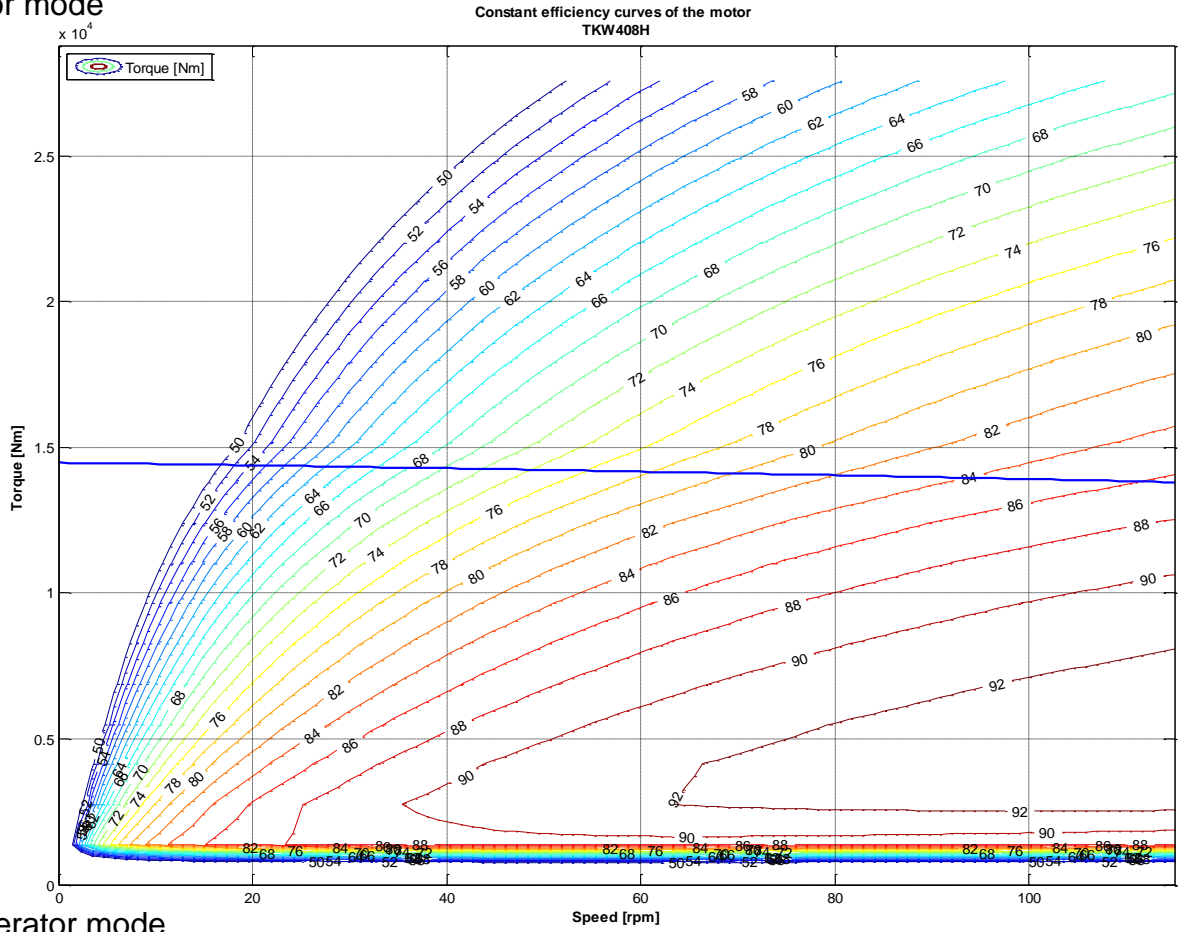

Generator mode

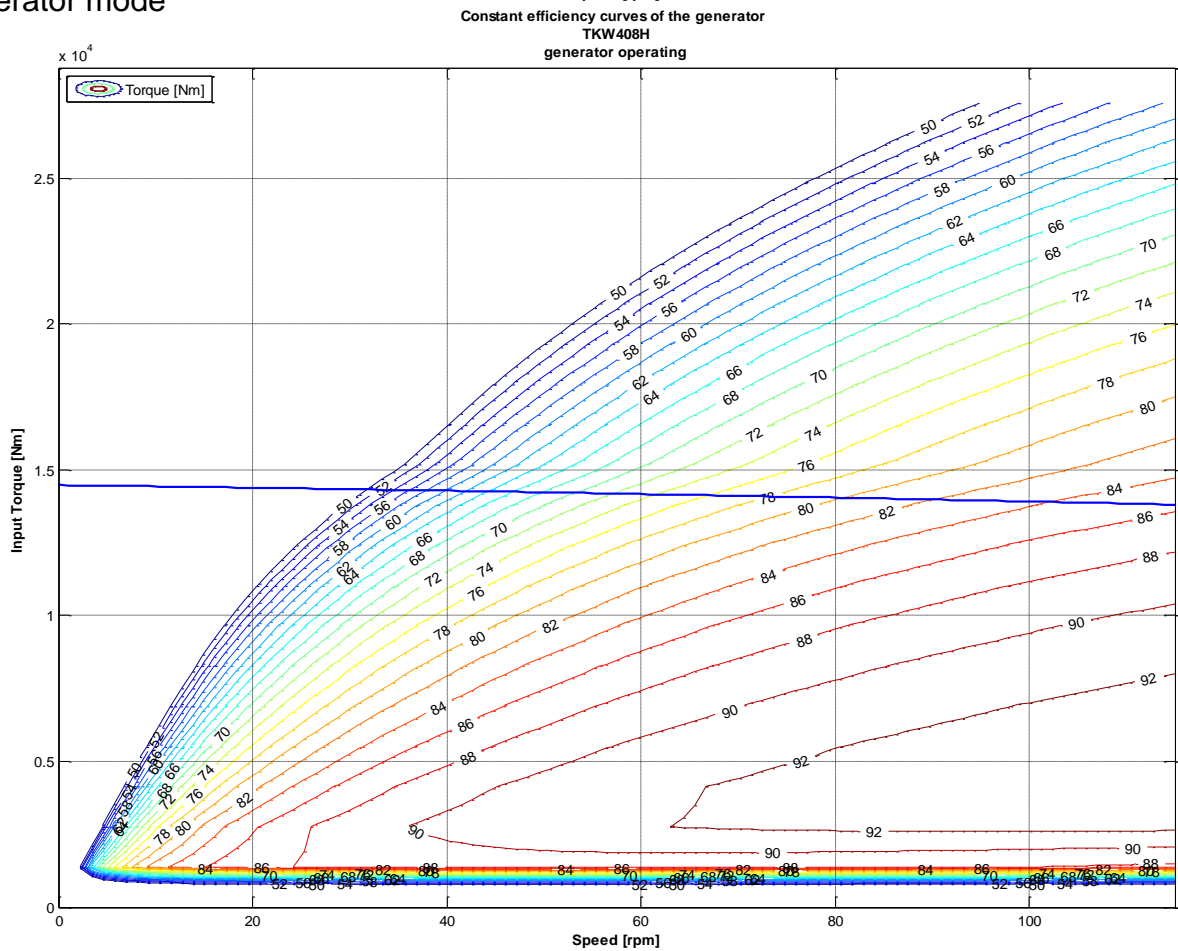



3.2.5.28. TKW40AH

Motor mode

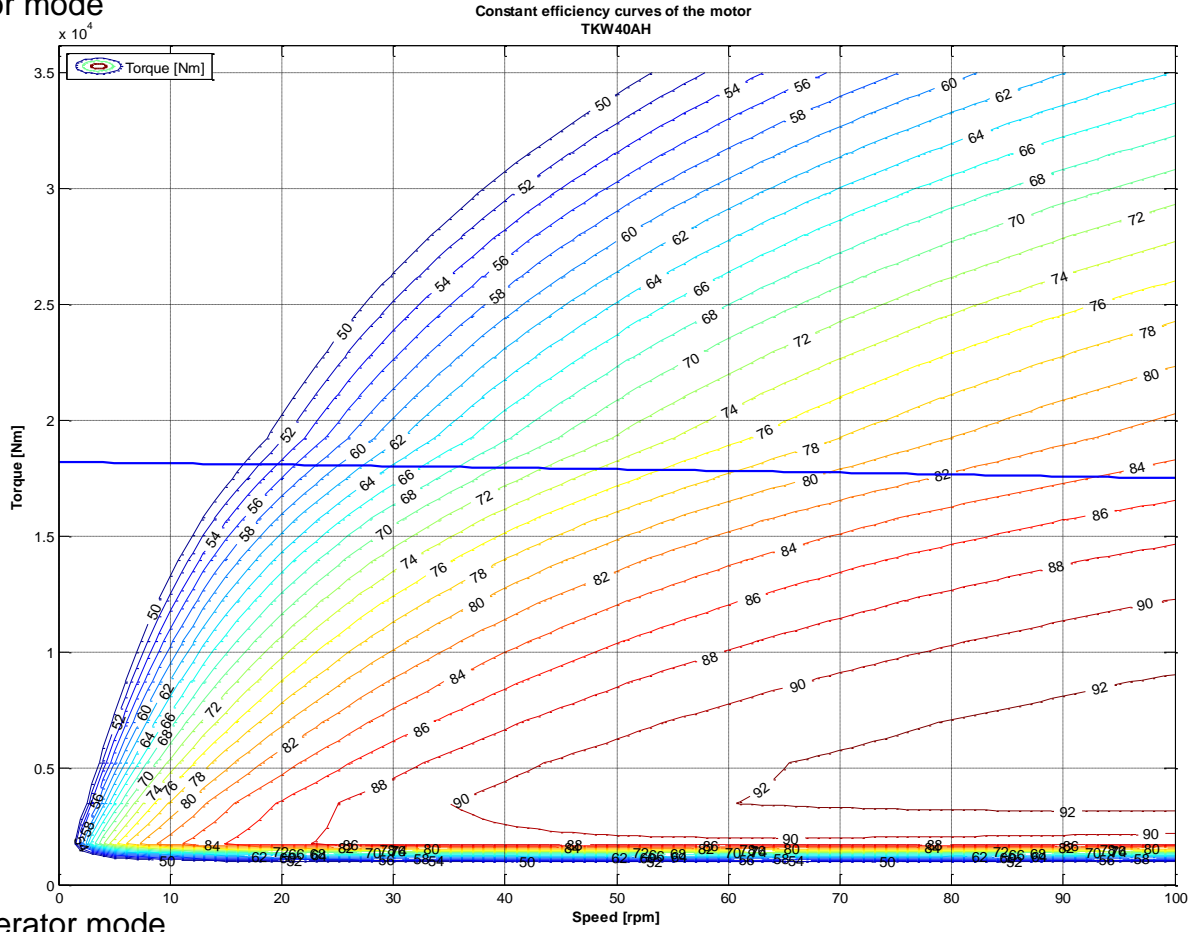

Generator mode

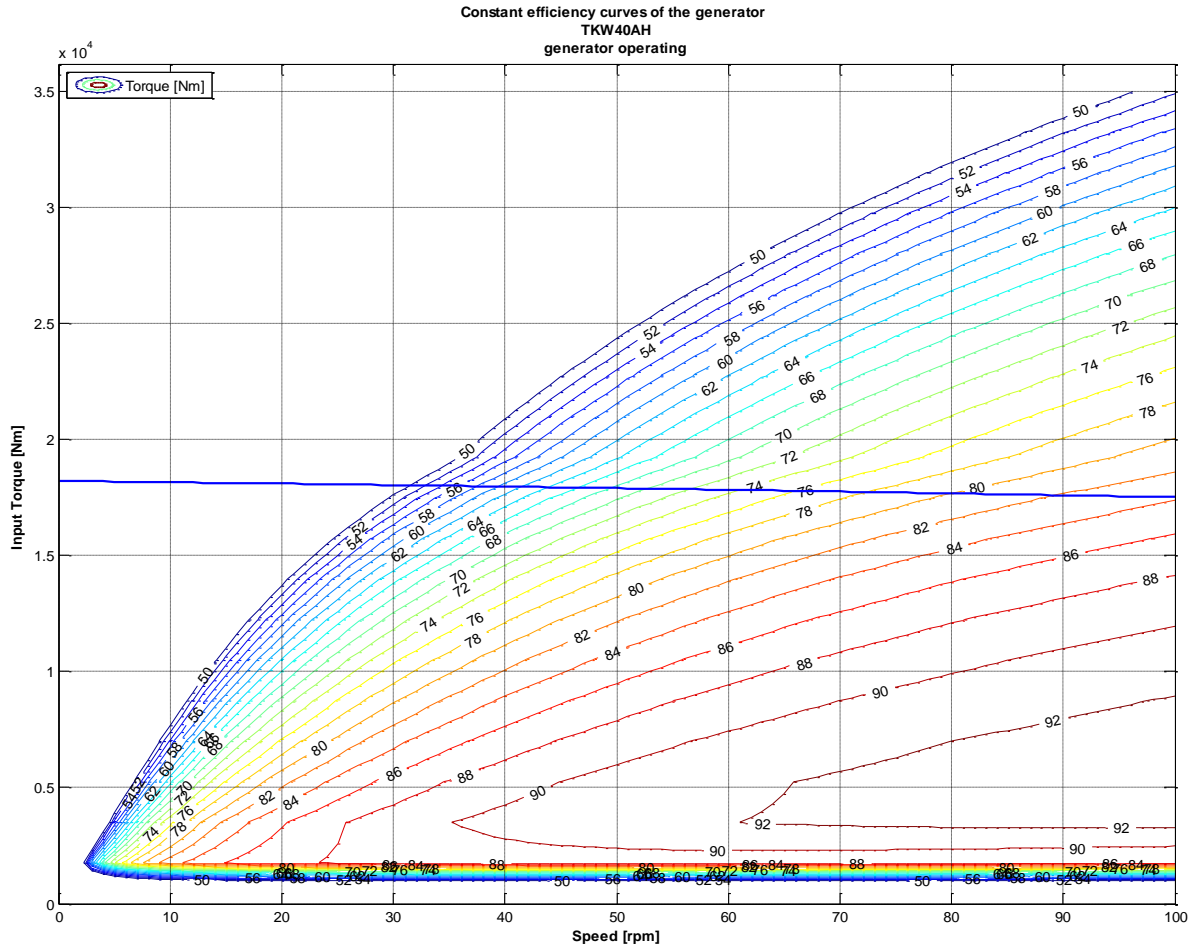



3.2.5.29. TKW40CH

Motor mode

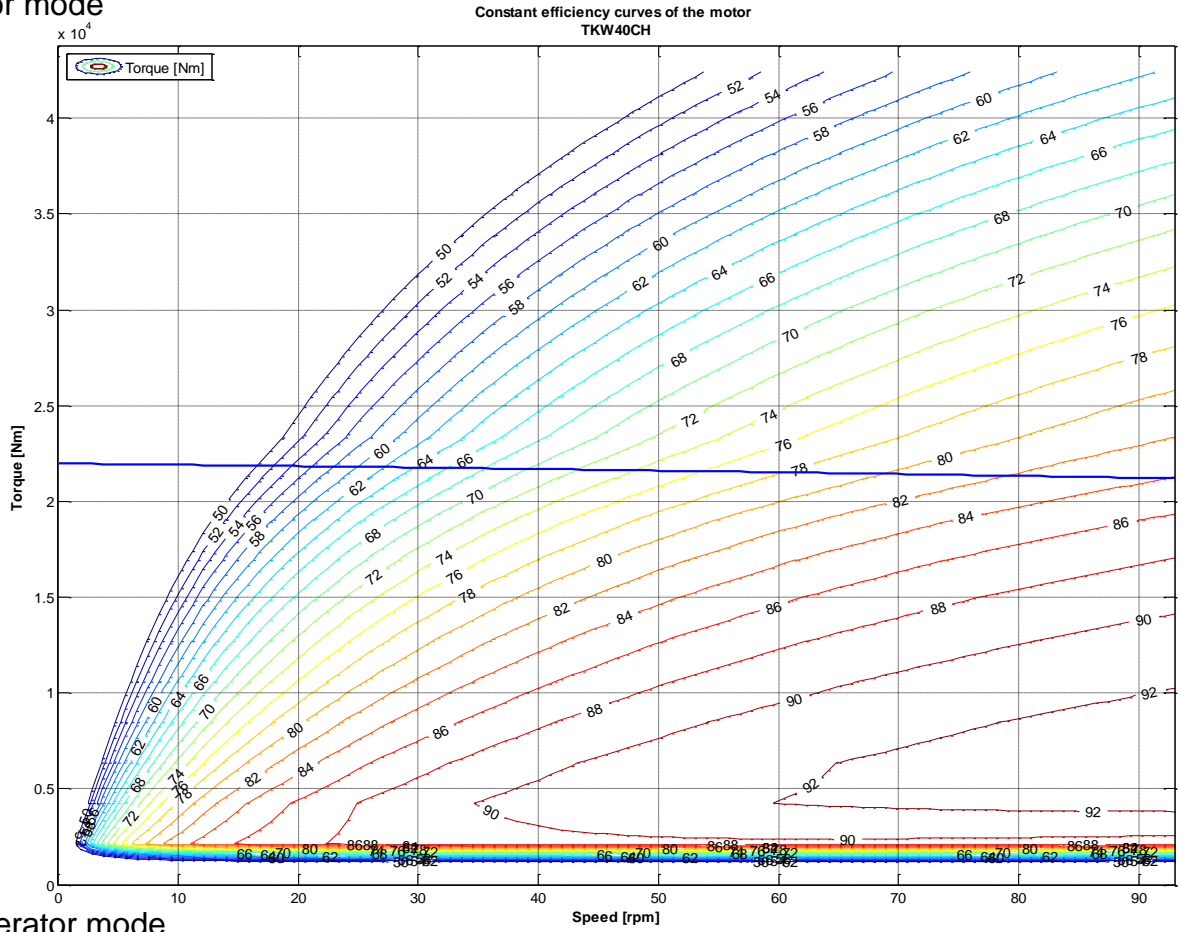

Generator mode

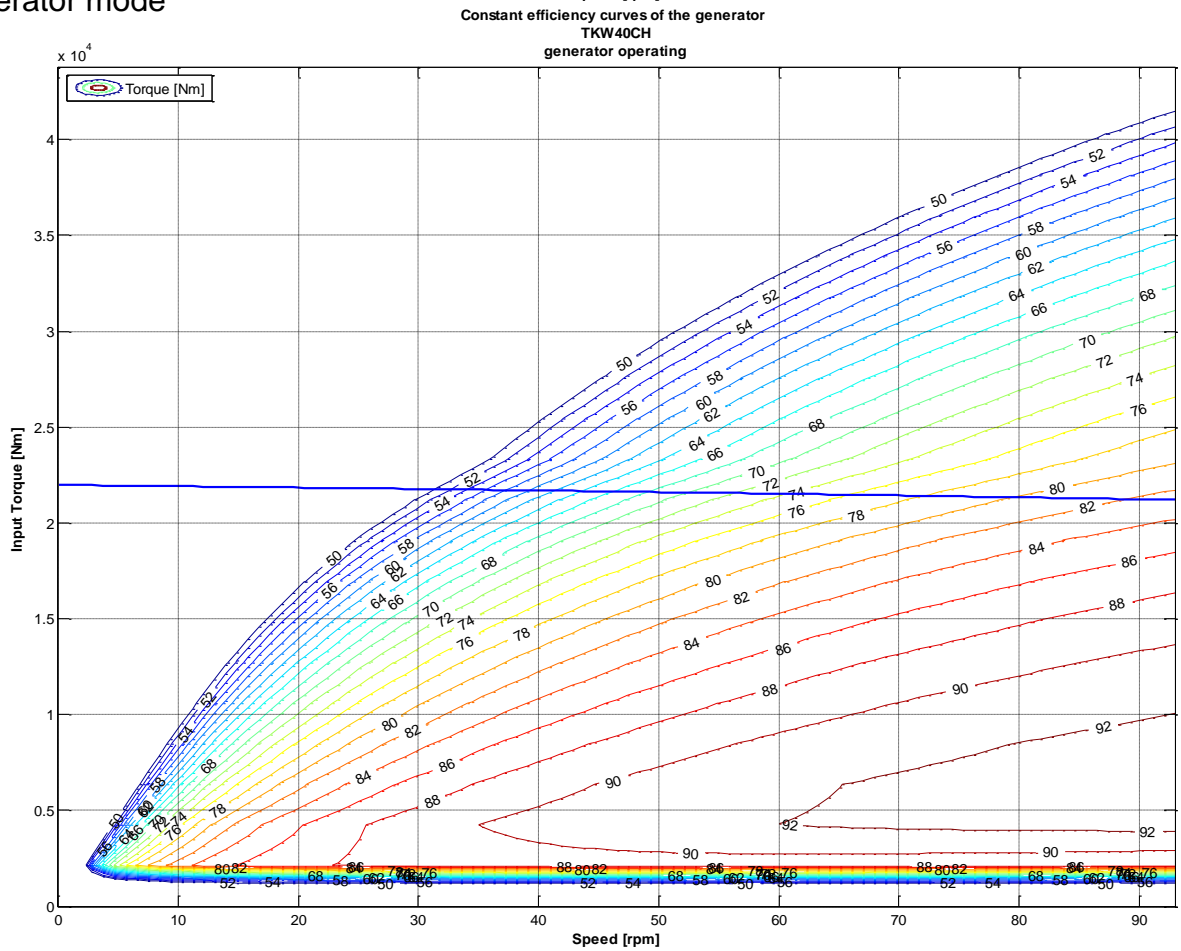

3.2.6. Electromagnetic losses

	<p><u>Caution:</u> Following data result from our best estimations but are indicative. They can vary from one motor to another and with temperature. No responsibility will be accepted for direct or indirect losses or damages due to the use of these data.</p>
---	--

Tf: Rotor shaft Dynamic Friction
 Kd: Rotor shaft Viscous Damping
 Torque losses = Tf + Kd x speed/1000

(Following data are indicative)

Type	Tf [Nm]	Kd [Nm/1000rpm]
TKA131H	0,6	0,8
TKA132H	1,2	1,8
TKA133H	1,8	2,6
TKA134H	2,4	3,6
TKA135H	3,0	4,5
TKA136H	3,6	5,4
TKA201H	2,1	6,3
TKA202H	4,3	13,0
TKA203H	6,5	20,0
TKA204H	8,7	27,2
TKA205H	10,9	34,1
TKA206H	13,0	40,7
TKA208H	17,4	55,2
TKA301H	5,6	23,9
TKA302H	11,3	48,7
TKA303H	16,9	73,9
TKA304H	22,5	98,1
TKA305H	28,2	123,3
TKA306H	33,9	149,3
TKA308H	45,2	201,1
TKA30AH	56,6	253,3
TKA401H	12,1	73,2
TKA402H	24,3	147,6
TKA403H	36,5	223,6
TKA404H	48,9	302,4
TKA405H	61,3	381,1
TKA406H	73,7	459,8
TKA408H	98,5	616,0
TKA40AH	123,4	775,1
TKA40CH	148,1	931,3

Type	Tf [Nm]	Kd [Nm/1000rpm]
TKW131H	0,7	1,2
TKW132H	1,5	3,1
TKW133H	2,2	4,6
TKW134H	3,1	6,6
TKW135H	4,0	8,9
TKW136H	4,8	10,8
TKW201H	2,4	9,1
TKW202H	5,0	20,3
TKW203H	6,7	22,4
TKW204H	9,9	39,6
TKW205H	13,1	55,3
TKW206H	16,7	75,9
TKW208H	20,1	81,3
TKW301H	6,4	36,8
TKW302H	13,7	83,9
TKW303H	20,7	128,6
TKW304H	28,0	175,8
TKW305H	35,2	223,2
TKW306H	42,5	270,8
TKW308H	57,1	366,1
TKW30AH	71,6	461,6
TKW401H	14,5	107,8
TKW402H	30,6	238,0
TKW403H	44,9	343,6
TKW404H	60,6	467,2
TKW405H	78,3	618,8
TKW406H	96,8	780,9
TKW408H	123,4	964,6
TKW40AH	163,3	1329,1
TKW40CH	204,6	1713,4

3.2.7. Time constants of the motor

3.2.7.1. Electric time constant:

$$\tau_{elec} = \frac{L_{ph_ph}}{R_{ph_ph}}$$

With following values given in the motor data sheet
 L_{ph_ph} inductance of the motor phase to phase [H],
 R_{ph_ph} resistance of the motor phase to phase at 25°C [Ohm].

Example:

Motor series TMK306HF

$L_{ph_ph} = 0.984 \text{ mH}$ or $0.984 \cdot 10^{-3} \text{ H}$

R_{ph_ph} at 25°C = 0.11 Ohm

→ $\sigma_{elec} = 8.95 \text{ ms}$

An overall summary of motor time constants is given a little further.

3.2.7.2. Mechanical time constant:

$$\tau_{mech} = \frac{0.5 * R_{ph_ph} * J}{(K_{eph_ph})^2}$$

With following values obtained from the motor data sheet:
 R_{ph_ph} resistance of the motor phase to phase at 25°C [Ohm],
 J inertia of the rotor [kgm²], (motor rotor + customer shaft)
 K_{eph_ph} back emf coefficient phase to phase [$V_{rms}/rad/s$].

The coefficient K_{eph_ph} in the formula above is given in [$V_{rms}/rad/s$]

To calculate this coefficient from the datasheet, use the following relation:

$$K_{eph_ph} [V_{rms}/rad/s] = \frac{K_{eph_ph} [V_{rms}/1000rpm]}{\frac{2 * \pi * 1000}{60}}$$

Example:

Motor series TKW306HF

R_{ph_ph} at 25°C = 0.11 Ohm

$J = 3.4 \text{ kg.m}^2 + 1 \text{ kg.m}^2$ for example for the customer shaft = 4.4 kg.m²

$K_{eph_ph} [V_{rms}/1000rpm] = 1280 [V_{rms}/1000rpm]$

→ $K_{eph_ph} [V_{rms}/rad/s] = 1280 / (2 * \pi * 1000 / 60) = 12.223 [V_{rms}/rad/s]$

→ $\sigma_{mech} = 0.5 * 0.11 * 4.4 / (12.223^2) = 1.6 \text{ ms}$

Remarks:

For a DC motor, the mechanical time constant σ_{mech} represents the duration needed to reach 63% of the final speed when applying a voltage step without any resistant torque, if the electrical time constant is much smaller than the mechanical time constant.

An overall summary of motor time constants is given a little further.

3.2.7.3. Thermal time constant of the copper:

$$\tau_{therm} = Rth_{copper_iron} * Cth_{copper}$$

$$Cth_{copper[J/^{\circ}K]} = Mass_{copper[kg]} * 389_{[J/kg^{\circ}K]}$$

Rth_{copper_iron} thermal resistance between copper and iron [$^{\circ}K/W$]

Cth_{copper} thermal capacity of the copper [$J/^{\circ}K$]

$Mass_{copper}$ mass of the copper (winding) [kg]

Hereunder is given an overall summary of motor time constants:

Type	Electric time constant [ms]	Mechanical time constant without customer shaft [ms]	Thermal time constant of copper [s]
TKA131H	5,6	0,9	322
TKA132H	6,9	0,7	295
TKA133H	7,4	0,7	278
TKA134H	7,8	0,7	275
TKA135H	8,2	0,6	280
TKA136H	8,3	0,6	275
TKA201H	6,2	1,2	379
TKA202H	7,9	1,0	367
TKA203H	8,3	0,9	349
TKA204H	8,8	0,8	349
TKA205H	9,2	0,8	348
TKA206H	9,1	0,8	338
TKA208H	9,3	0,8	336
TKA301H	5,8	2,1	384
TKA302H	7,5	1,6	378
TKA303H	8,4	1,4	383
TKA304H	8,8	1,3	376
TKA305H	9,1	1,3	377
TKA306H	9,5	1,2	384
TKA308H	9,3	1,3	364
TKA30AH	9,2	1,3	374
TKA401H	7,8	1,9	403
TKA402H	10,3	1,3	427
TKA403H	10,9	1,3	418
TKA404H	11,3	1,2	414
TKA405H	11,5	1,2	412
TKA406H	12,2	1,1	426
TKA408H	12,5	1,1	429
TKA40AH	12,2	1,1	413
TKA40CH	13,1	1,0	439
TKW131H	5,6	0,9	62
TKW132H	6,9	0,7	49
TKW133H	7,4	0,7	44
TKW134H	7,7	0,7	42
TKW135H	7,8	0,6	41
TKW136H	8,1	0,6	41
TKW201H	6,1	1,2	103
TKW202H	7,5	1,0	81
TKW203H	8,1	0,9	73
TKW204H	8,5	0,8	71
TKW205H	8,9	0,8	70
TKW206H	9,0	0,8	69
TKW208H	9,1	0,8	66
TKW301H	6,1	2,0	109
TKW302H	7,6	1,6	88
TKW303H	8,3	1,4	81
TKW304H	8,7	1,3	76
TKW305H	8,8	1,3	74
TKW306H	8,9	1,3	71
TKW308H	9,2	1,2	70
TKW30AH	9,4	1,2	69
TKW401H	7,8	1,9	131
TKW402H	10,0	1,4	106
TKW403H	10,9	1,2	87
TKW404H	11,8	1,1	84
TKW405H	11,4	1,2	86
TKW406H	11,6	1,1	85
TKW408H	12,2	1,1	85
TKW40AH	12,4	1,0	83
TKW40CH	12,7	1,0	84



3.2.8. Speed ripple

Following values are given as indicative data because depending on the settings of the drive (gains of both speed and current regulation loops, presence of filtering or not, load inertia, resistant torque and type of sensor in use). The data below correspond to a motor type TKW206HS without external load (neither external inertia nor resistant torque).

(Following data are indicatives)

Sensor	Speed ripple peak to peak [%]
Resolver in direct	3.6% ... 5.8%
Endat in direct	1%

3.2.9. Rated data according to rated voltage variation

The nominal characteristics and especially the rated speed, maximal speed, rated power, rated torque, depend on the nominal voltage supplying the motor considered as the rated voltage. The rated data mentioned in the data sheet are given for each association of motor and drive. Therefore, if the supply voltage changes, the rated values will also change. As long as the variation of the rated voltage remains limited, for instance $\pm 10\%$ of the nominal value, it is possible to correctly evaluate the new rated values as illustrated below.

Example:

Extract of TKW306HF datasheet

BRUSHLESS MOTOR TKW306HF ELECTRONIC DRIVE AC890SD - 250 Arms	
---	--

P _n	Rated power	113	kW	Cooling : water cooling Cooling : IC 97 W Minimum flow : 22 l / min Maximum temperature : 25 °C Maximum pressure : 5 bars
M _n	Rated torque	4710	Nm	
N _n	Rated speed	230	rpm	
I _n	Rated current	235	A _{rms}	
U _n	Rated voltage	356	V _{rms}	
UR	Voltage of the mains	400	V _{rms}	
U	DC voltage supply when motor is loaded	540	V	
M _o	Low speed torque	4950	Nm	
I _b	Permanent current at low speed	245	A _{rms}	
M _p	Max. torque	7110	Nm	
I _p	Max. current	367	A _{rms}	
N _p	Max. speed	340	rpm	
J	Rotor inertia	3.4	kg.m ²	
Ke	Back emf constant at 1000 rpm (25°C)*	1280	V _{rms}	
Kt	Torque sensitivity	20.2	Nm/A _{rms}	
R _b	Winding resistance(25°C) *	0.11	Ω	
L	Winding inductance *	0.984	mH	

All data are given in typical values under standard conditions

* Phase to phase **without thrust-bearing

If we suppose that the rated voltage $U_n=356 \text{ V}_{\text{rms}}$ decreases of **10%** ; this means that the new rated voltage becomes $U_{n2}=320 \text{ V}_{\text{rms}}$.

Rated speed:

The former rated speed $N_n=230 \text{ rpm}$ obtained with a rated voltage $U_n=347 \text{ V}_{\text{rms}}$ and an efficiency of $\eta=88.4\%$ leads to the new rated speed N_{n2} given as follows:

$$N_{n2} = N_n * \frac{\frac{U_{n2}}{U_n} - 1 + \eta}{\eta} \qquad N_{n2} = 230 * \frac{\frac{320}{356} - 1 + 0.884}{0.884} = 203 \text{rpm}$$

Maximum speed:

The former maximum speed $N_{\text{max}} = 340 \text{ rpm}$ obtained with $U_n = 356 \text{ V}_{\text{rms}}$ and $N_n = 230 \text{ rpm}$ leads to the new maximum speed $N_{\text{max}2}$ given as follows:

$$N_{\text{max}2} = N_{\text{max}} * \frac{N_{n2}}{N_n} \qquad N_{\text{max}2} = 340 * \frac{203}{230} = 300 \text{rpm}$$

N.B.

- If the rated voltage increases
- ($U_{n2} > U_n$), the new rated speed N_{n2} and the new maximum speed $N_{\text{max}2}$ will be greater than the former ones N_n and N_{max} . Moreover you will have to check that the drive still shows able to deal with the new maximum electric frequency.

	<p><u>Warning:</u> If the main supply decreases, you must reduce the maximum speed accordingly in order not damage the motor. In case of doubt, consult us.</p>
---	---

Rated power:

The former rated power $P_n=113 \text{ kW}$ obtained with $U_n = 356 \text{ V}_{\text{rms}}$ leads to the new rated power P_{n2} given as follows:

$$P_{n2} = P_n * \frac{U_{n2}}{U_n} \qquad P_{n2} = 113 * \frac{320}{356} = 101 \text{kW}$$

Rated torque:

The former rated torque $M_n = 21700 \text{ Nm}$ obtained with $U_n = 347 \text{ V}_{\text{rms}}$ leads to the new rated torque M_{n2} given as follows:

$$M_{n2} = \frac{P_{n2}}{\frac{2 * \pi * N_{n2}}{60}} \qquad M_{n2} = \frac{101000}{\frac{2 * \pi * 203}{60}} = 4751 \text{Nm}$$

3.2.10. Voltage withstand characteristics of TK series

The motors fed by converters are subject to higher stresses than in case of sinusoidal power supply. The combination of fast switching inverters with cables will cause over voltage due to the transmission line effects. The peak voltage is determined by the voltage supply, the length of the cables and the voltage rise time. As an example, with a rise time of 200 ns and a 30 m (100 ft) cable, the voltage at the motor terminals is twice the inverter voltage.

The insulation system of the torque motors TK is designed to withstand high repetitive pulse voltages and largely exceeds the recommendations of the IEC/TS 60034-25 ed 2.0 2007-03-12 for motors without filters up to 690V AC (See figure 1).

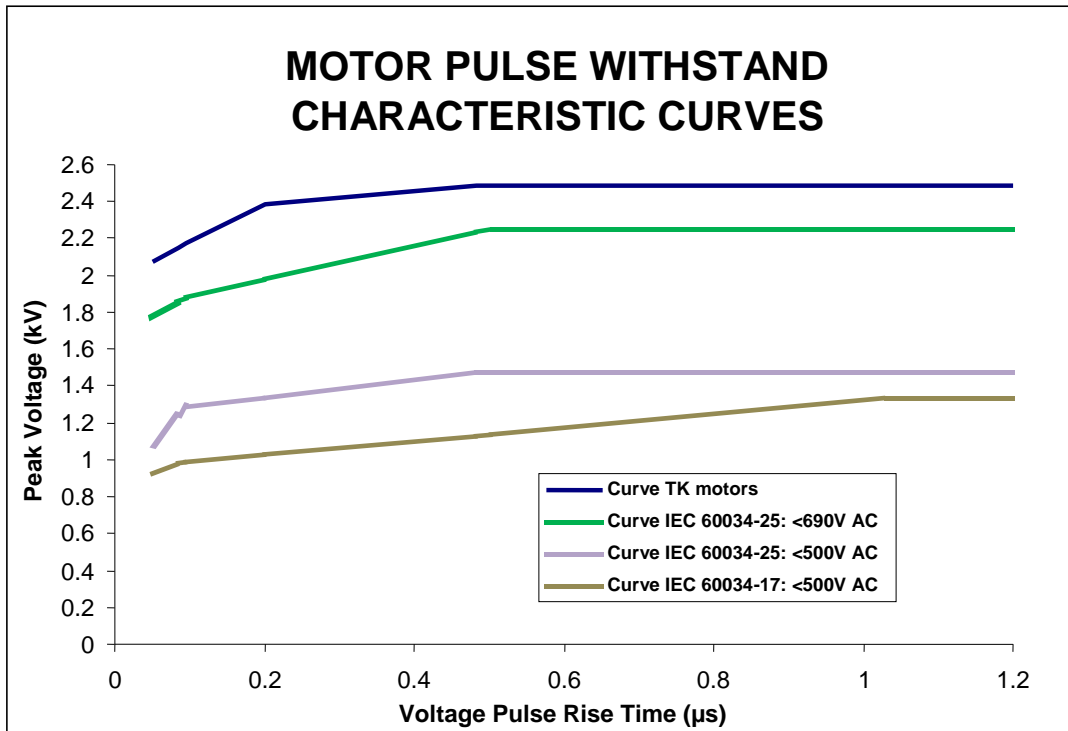

Figure 1: Minimum Voltage withstands characteristics for motors insulations according to IEC standards. At the top are the typical capabilities for the TM motors.

Note: The pulse rise times are defined in accordance with the IEC/TS 60034-17 ed4.0 2006-05-09.

The TM motors can be used with a supply voltage up to 690 V under the following conditions:

- The pulse rise times must be longer than 50 ns.
- The repetitive pulse voltages must not exceed the values given in figure 1, “Curve TK motors” in dark blue.

3.3. Dimension drawings

3.3.1. TKA130 standard configuration

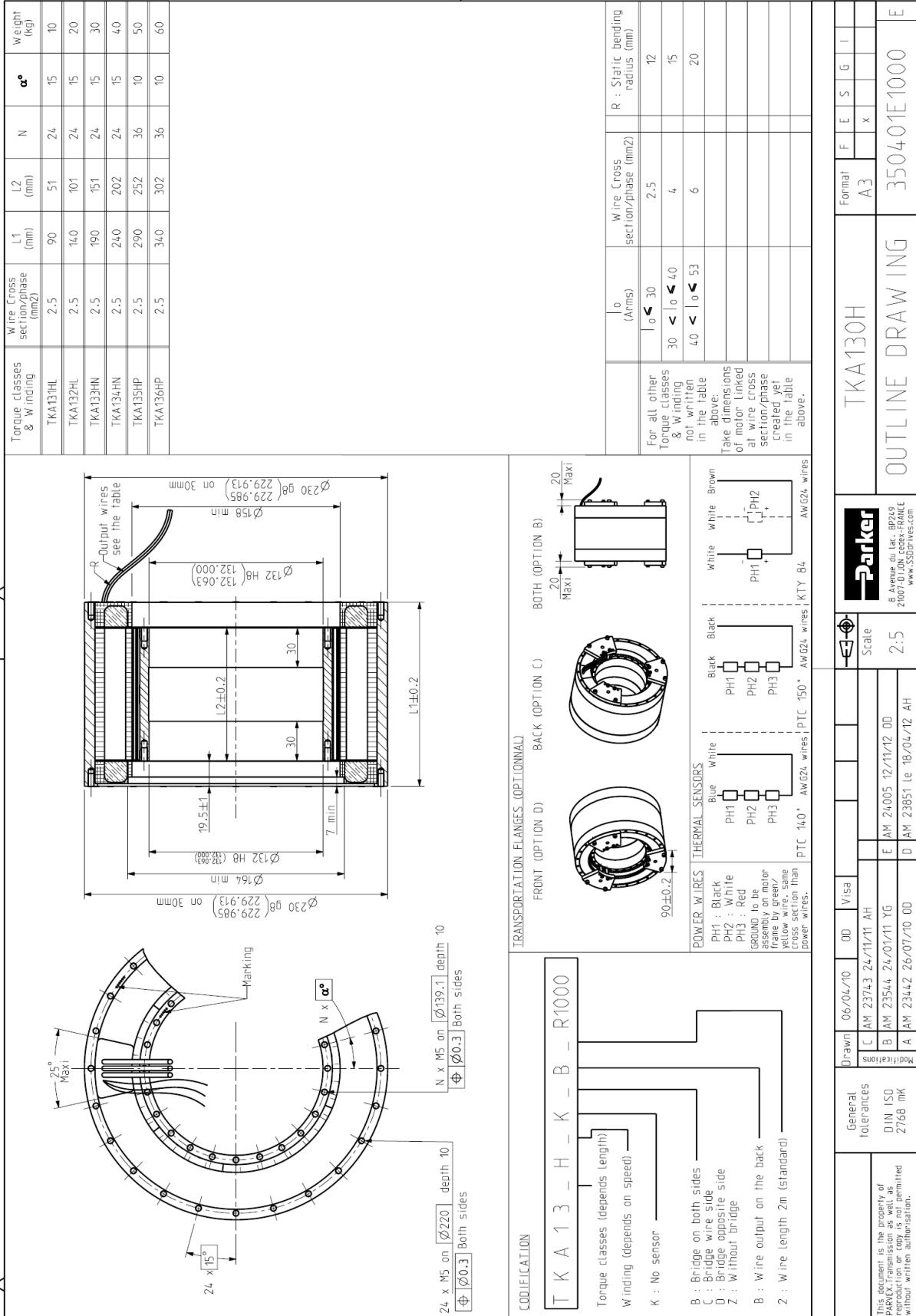

3.3.2. TKA200 standard configuration

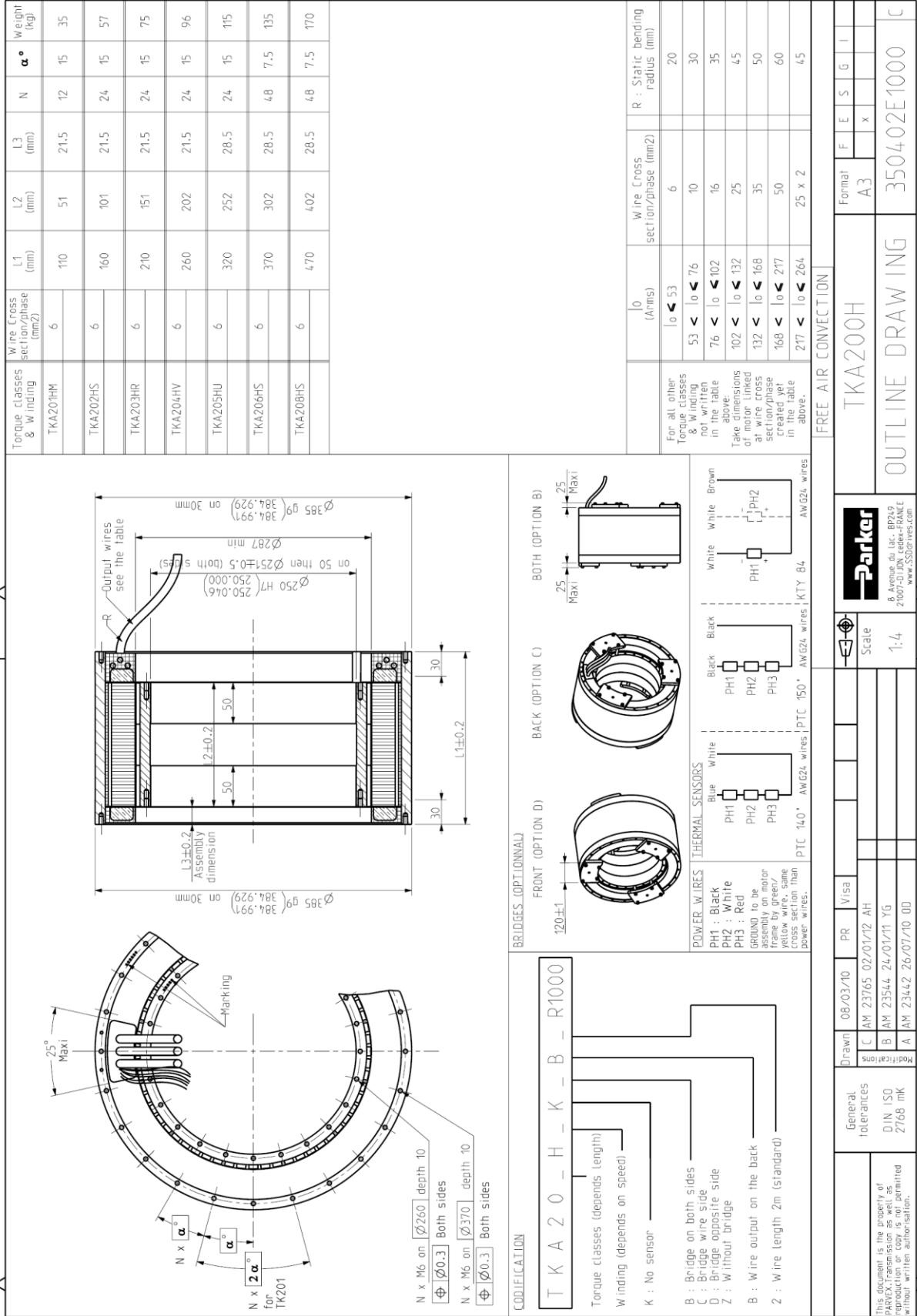

Torque classes & Winding	Wire Cross section/phase (mm ²)	L1 (mm)	L2 (mm)	L3 (mm)	N	α°	Weight (kg)
TKA201HM	6	110	51	21.5	12	15	35
TKA202HS	6	160	101	21.5	24	15	57
TKA203HR	6	210	151	21.5	24	15	75
TKA204HV	6	260	202	21.5	24	15	96
TKA205HU	6	320	252	28.5	24	15	115
TKA206HS	6	370	302	28.5	48	7.5	135
TKA208HS	6	470	402	28.5	48	7.5	170

For all other Torque classes & Winding not written in the table above. Take dimensions of motor linked at wire cross section/phase created yet in the table above.	Wire Cross section/phase (mm ²)		R : Static bending radius (mm)
	0 (Arms)	6	
	$10 \leq 53$	6	20
	$53 < 10 \leq 76$	10	30
	$76 < 10 \leq 102$	16	35
	$102 < 10 \leq 132$	25	45
	$132 < 10 \leq 168$	35	50
	$168 < 10 \leq 217$	50	60
	$217 < 10 \leq 264$	25 x 2	45

MODIFICATION

TKA20-H-K-B-R1000

Torque classes (depends Length)
Winding (depends on speed)

K : No sensor
B : Bridge on both sides
C : Bridge wire side
D : Bridge opposite side
Z : W/Inout bridge
B : Wire output on the back
2 : Wire length 2m (standard)

General tolerances
DIN ISO 2768 mk

Drawn: 08/03/10 PR Visa
C AM 23765 02/01/12 AH
B AM 23544 24/01/11 YG
A AM 23442 26/07/10 OD

Scale: 1:4

Format: A3
F E S G I
x

TKA200H
OUTLINE DRAWING
350402E1000 C

Parker
8, Avenue du Lac, BP249
21007-DJONVILLE-FRANCE
www.parkerfr.com

3.3.3. TKA300 standard configuration

Torque classes & Winding	Wire Cross section/phase (mm ²)	L1 (mm)	L2 (mm)	L3 (mm)	N	α°	Weight (kg)
TKA301HJ	6	110	51	21.5	12	15	75
TKA302HP	6	160	101	21.5	24	15	113
TKA303HN	6	210	151	21.5	24	15	150
TKA304HN	6	255	202	21.5	24	15	185
TKA305HN	6	320	252	28.5	24	15	230
TKA306HM	10	370	302	28.5	48	7.5	270
TKA308HL	10	470	402	28.5	48	7.5	345
TKA30AHL	10	580	502	31.5	48	7.5	425

BRIDGES (OPTIONNAL)

TKA30 - H - K - B - R1000

Torque classes (depends length)
Winding (depends on speed)

K : No sensor
B : Bridge on both sides
C : Bridge wire side
D : Bridge opposite side
Z : Without bridge
B : Wire output on the back
2 : Wire length 2m (standard)

BACK (OPTION C)

FRONT (OPTION D)

BOTH (OPTION B)

THERMAL SENSORS

PH1 : Black
PH2 : White
PH3 : Red

Blue
White

PH1 PH2 PH3

PH1 PH2 PH3

White
Black

PH1 PH2 PH3

White
Black
Brown

PH1 PH2 PH3

AWG24 wires | PTC 150° AWG24 wires | KTY 84
AWG24 wires

General tolerances		Drawn		PR		Visa	
DIN ISO 2768 mK		C AM 23765	02/01/12	AH			
		B AM 23544	24/01/11	Y5			
		A AM 23442	26/07/10	00			

FREE AIR CONNECTION		Format	
TKA300H		F	E S G I
OUTLINE DRAWING		A3	X
		350403E1000 C	

For all other Torque classes & Winding not written in the table above

Take dimensions of motor linked at wire cross section/phase created yet in the table above.

Wire Cross section/phase (mm ²)	Wire Cross section/phase (mm ²)	R : Static bending radius (mm)
6	6	20
10	10	30
16	16	35
25	25	45
35	35	50
50	50	60
25 x 2	25 x 2	45
35 x 2	35 x 2	50
50 x 2	50 x 2	60

Scale 1:5

© Parker Hannifin Corp. 2007-2016. PARKER
www.parker.com

3.3.4. TKA400 standard configuration

Torque classes & winding	Wire Cross section/phase (mm ²)	L1 (mm)	L2 (mm)	L3 (mm)	N	α°	Weight (kg)
TKA401HG	6	110	51	23.5	16	11.25	130
TKA402HP	6	160	101	23.5	32	11.25	202
TKA403HL	10	215	151	23.5	32	11.25	275
TKA404HR	10	265	202	23.5	32	11.25	345
TKA405HQ	10	330	252	30.5	32	11.25	420
TKA406HP	16	385	302	30.5	64	5.625	490
TKA408HN	16	485	402	30.5	64	5.625	630
TKA40AHM	16	590	502	33.5	64	5.625	770
TKA40CHK	25	700	602	33.5	64	5.625	915

Wire Cross section/phase (mm ²)	Wire Cross section/phase (mm ²)	R : Static bending radius (mm)
6	6	20
10	10	30
16	16	35
25	25	45
35	35	50
50	50	60
25 x 2	25 x 2	45
35 x 2	35 x 2	50
50 x 2	50 x 2	60
70 x 2	70 x 2	70

For all other Torque classes & winding not written in the table above:
Take dimensions of motor linked to wire cross section created in the table above.

BRIDGES (OPTIONAL)

FRONT (OPTION D)

BACK (OPTION C)

BOTH (OPTION B)

THERMAL SENSORS

Blue White
PH1 PH2 PH3
PTC 14.0° AWG24 wires PTC 150° AWG24 wires KTY B4

POWER WIRES

PH1 : Black
PH2 : White
PH3 : Red
GROUND to be made by the customer using yellow/green cross section than power wires.

White Brown
PH1 PH2

CODEIFICATION

T K A 4 0 - H - K - B - R1000

Torque classes (depends length)
Winding (depends on speed)
K : No sensor
B : Bridge on both sides
C : Bridge wire side
D : Bridge opposite side
Z : Without bridge
B : Wire output on the back
2 : Wire length 2m (standard)

FREE AIR CONVECTION

TKA400H

OUTLINE DRAWING

Format: F E S G I
A3 x
350404E1000 C

Scale: 3:20

Drawn: 08/03/10 PR V15a

General tolerances: DIN ISO 2768 mK

Modifications: A AM23442 26/07/10 DD

Scale: 3:20

Drawn: 08/03/10 PR V15a

General tolerances: DIN ISO 2768 mK

Modifications: A AM23442 26/07/10 DD

Scale: 3:20

Drawn: 08/03/10 PR V15a

General tolerances: DIN ISO 2768 mK

Modifications: A AM23442 26/07/10 DD

Scale: 3:20

Drawn: 08/03/10 PR V15a

General tolerances: DIN ISO 2768 mK

Modifications: A AM23442 26/07/10 DD

Scale: 3:20

Drawn: 08/03/10 PR V15a

General tolerances: DIN ISO 2768 mK

Modifications: A AM23442 26/07/10 DD

Scale: 3:20

Drawn: 08/03/10 PR V15a

General tolerances: DIN ISO 2768 mK

Modifications: A AM23442 26/07/10 DD

Scale: 3:20

Drawn: 08/03/10 PR V15a

General tolerances: DIN ISO 2768 mK

Modifications: A AM23442 26/07/10 DD

Scale: 3:20

Drawn: 08/03/10 PR V15a

General tolerances: DIN ISO 2768 mK

Modifications: A AM23442 26/07/10 DD

Scale: 3:20

Drawn: 08/03/10 PR V15a

General tolerances: DIN ISO 2768 mK

Modifications: A AM23442 26/07/10 DD

Scale: 3:20

Drawn: 08/03/10 PR V15a

General tolerances: DIN ISO 2768 mK

Modifications: A AM23442 26/07/10 DD

3.3.5. TKW130 standard configuration

Customer housing with cooling
Seal O ring $\varnothing 210 \times 3$
Water cooling inlet / outlet
Seal O ring $\varnothing 210 \times 3$
Output wires see the table
 $\varnothing 158$ min
 $\varnothing 132$ H8
 $\varnothing 230$ f8
 $L2 \pm 0.2$
 $L1 \pm 0.2$
15
15
30
30
7 min
 $\varnothing 164$ min
 $\varnothing 230$ f8
 19.5 ± 0.2
25
25

Torque classes & Winding	Wire Cross section/phase (mm ²)	L1 (mm)	L2 (mm)	L3 (mm)	N	α°	Weight (kg)
TKW131HL	2.5	90	51	40	24	15	15
TKW131HC	6	100					
TKW132HL	2.5	140	101	90	24	15	20
TKW132HN	2.5						
TKW132HF	6	150					
TKW133HN	4	190		140	24	15	35
TKW133HH	10	205	151				
TKW133HD	25	225		158.5			
TKW134HN	4	246					
TKW134HJ	10	256	202	196	24	15	45
TKW134HF	25	276		213			
TKW135HM	10	306	252	256	36	10	55
TKW135HG	25	326					
TKW136HM	10	356	302	306	36	10	65
TKW136HF	35	376					

24 x M5 on $\varnothing 220$ depth 10
 $\varnothing 0.3$ Both sides
N x M5 on $\varnothing 139.1$ depth 10
 $\varnothing 0.3$ Both sides
Marking
 $N \times \alpha^\circ$
25° Maxi

TRANSPORTATION FLANGES (OPTIONAL)

FRONT (OPTION D) BACK (OPTION C) BOTH (OPTION B)

POWER WIRES

PH1 : Black
PH2 : White
PH3 : Red
GROUND to be assembly on motor frame by green/yellow wire, same length as the other power wires.

THERMAL SENSORS

Blue White
PH1 PH2 PH3

Black Black
PH1 PH2 PH3

White White Brown
PH1 PH2

AWG24 wires | PTC 140° | AWG24 wires | PTC 150° | AWG24 wires | KTY 84 | AWG24 wires

CODEIFICATION

TKW 13 - H - K - B - R1000

Torque classes (depends length)
Winding (depends on speed)
K : No sensor
B : Bridge on both sides
C : Bridge wire side
D : Bridge opposite side
Z : Without bridge
B : Wire output on the back
2 : Wire length 2m (standard)

WATER COOLING

TKW 130H

OUTLINE DRAWING

Format: A3

Scale: 2:5

350301E1000

F E S G I

3.3.8. TKW400 standard configuration

Customer housing with cooling inlet / outlet
Seal O Ring
Seal O ring
Ø760x4
L4
L5
L3
L2
L1
Wire Cross section/phase (mm²)
Torque classes & Winding
N
α°
Weight (kg)

Output wires see the table
666 mini
Ø795 f9 (794.92)
Ø792.920 f8 (792.795) for TK405 to TK40C (A side)
Ø795 f9 (794.92)
Ø620 HT (620.07) on 50 then Ø621±0.5 (both sides)
L3±0.2 Assembly dimension
L2±0.2
50
50
18
18
11±0.2

25° Maxi
Marking
N x M8 on Ø635 depth 15
N x M8 on Ø778 depth 15
N x M8 on Ø778 depth 15
N x M8 on Ø778 depth 15

Torque classes & Winding	Wire Cross section/phase (mm ²)	L1 (mm)	L2 (mm)	L3 (mm)	L4 (mm)	L5 (mm)	N	α°	Weight (kg)
TKW401HD	10	130	51	23.5	45	40	16	11.25	137
TKW401HA	25	180	101	23.5	45	90	32	11.25	209
TKW402HP	16	180	101	23.5	45	90	32	11.25	209
TKW402HI	35	180	101	23.5	45	90	32	11.25	209
TKW402HG	50	180	101	23.5	45	90	32	11.25	209
TKW403HL	25	230	151	23.5	45	140	32	11.25	280
TKW403HJ	35	230	151	23.5	45	140	32	11.25	280
TKW403HC	25 x 2	230	151	23.5	45	140	32	11.25	280
TKW404HR	35	280	202	23.5	45	190	32	11.25	350
TKW404HO	35	280	202	23.5	45	190	32	11.25	350
TKW404HI	35 x 2	280	202	23.5	45	190	32	11.25	350
TKW405HD	35	350	252	30.5	45	260	32	11.25	430
TKW405HH	35 x 2	350	252	30.5	45	260	32	11.25	430
TKW406HQ	35	400	302	30.5	45	310	64	5.625	500
TKW406HP	35	400	302	30.5	45	310	64	5.625	500
TKW406HG	35 x 2	400	302	30.5	45	310	64	5.625	500
TKW408HQ	35	500	402	30.5	45	410	64	5.625	640
TKW408HN	50	500	402	30.5	45	410	64	5.625	640
TKW408HF	50 x 2	500	402	30.5	45	410	64	5.625	640
TKW40AHQ	35	605	502	33.5	45	515	64	5.625	780
TKW40AHM	25 x 2	605	502	33.5	45	515	64	5.625	780
TKW40AHE	50 x 2	605	502	33.5	45	515	64	5.625	780
TKW40CHK	25 x 2	710	602	33.5	45	620	64	5.625	920
TKW40CHD	70 x 2	710	602	33.5	45	620	64	5.625	920

For all other Torque classes & Winding not written in the table above: Take dimensions on Ø795 f9 (794.92) at wire cross section/phase created yet in the table above.

Wire Cross section/phase (mm²)
R : Static bending radius (mm)

CODEIFICATION

TKW40 - H - K - B - R1000

Torque classes (depends Length)
Winding (depends on speed)

K : No sensor
B : Bridge on both sides
C : Bridge wire side
D : Bridge opposite side
Z : W without bridge

B : Wire output on the back
2 : Wire length 2m (standard)

BRIDGES (OPTIONAL)

FRONT (OPTION D)
180±1

BACK (OPTION C)

BOTH (OPTION B)

25 Maxi
25 Maxi

POWER WIRES

PH1 : Black
PH2 : White
PH3 : Red

GROUND to be assembly on motor yellow wire, same cross section than power wires.

Blue White
PH1 PH2 PH3

Black White Brown
PH1 PH2

PTC 14.0 - AWG24 wires | PTC 150 - AWG24 wires | KTY 84 - AWG24 wires

General tolerances
DIN / ISO 2768 mK

Drawn 02/09/09
C AM23442 26/07/10 DD
B AM23421 08/06/10 DD
A AM23365 23/03/10 PR

Modifications

Scale 3:20

8 Avenue du Lac - BP249
2007-BJ JON-GENE-FRANCE
www.33001rep.com

WATER COOLING

TKW400H

OUTLINE DRAWING

Format A3
F E S G I
x

350304E1000

E

3.4. Motor mounting recommendations

	<p><u>Warning</u> : The recommendations in this chapter are general. It is the integrator responsibility to check if it complies with his application and to chose and define the correct way to integrate the kit according to his application, all the regulations and standards applicable.</p>
--	--

3.4.1. Frame recommendation

	<p><u>Warning</u> : The user has the entire responsibility to design and prepare the housing, the shaft, connection box, the support, the coupling device, shaft line alignment, and shaft line balancing.</p>
--	--

Machine design must be even, sufficiently rigid, precise and shall be dimensioned as to avoid vibrations due to resonances. Integrator bears the entire responsibility for choice of the key components, such as bearing, encoder, electric connection and mechanical parts design.

	<p><u>Warning</u> : A grade A motor (according to IEC 60034-14) well-balanced, may exhibit large vibrations when installed in-situ arising from various causes, such as unsuitable foundations, reaction of the driven motor, current ripple from the power supply, etc. Vibration may also be caused by driving elements with a natural oscillation frequency very close to the excitation due to the small residual unbalance of the rotating masses of the motor. In such cases, checks should be carried out not only on the machine, but also on each element of the installation. (See ISO 10816-3).</p>
--	--

	<p><u>Warning</u> : A bad setting of the electronic control of the close loop (gain too high, incorrect filtering ...) can occur an instability of the shaft line, vibration or/and breakdown - . Please consult us</p>
--	---

	<p>When the motor is delivered, customer interfaces (rotor or/and stator) can be oval with no impact on the mounting if mechanical interfaces is in accordance with following drawings. This ovality is completely reversible</p>
--	---

	<p><u>Warning</u> : the complete motor in natural cooling version must thermally well connected to a aluminium flange with the minimal surface (see § 3.5.1. Natural cooled motor)</p>
--	--

3.4.2. Mechanical interfaces

The mechanical interfaces requirements for the user structure must comply with the following drawing and values. Different solutions exist, two are described below, and other variants are possible.

3.4.2.1. Rotor and stator block on the same side

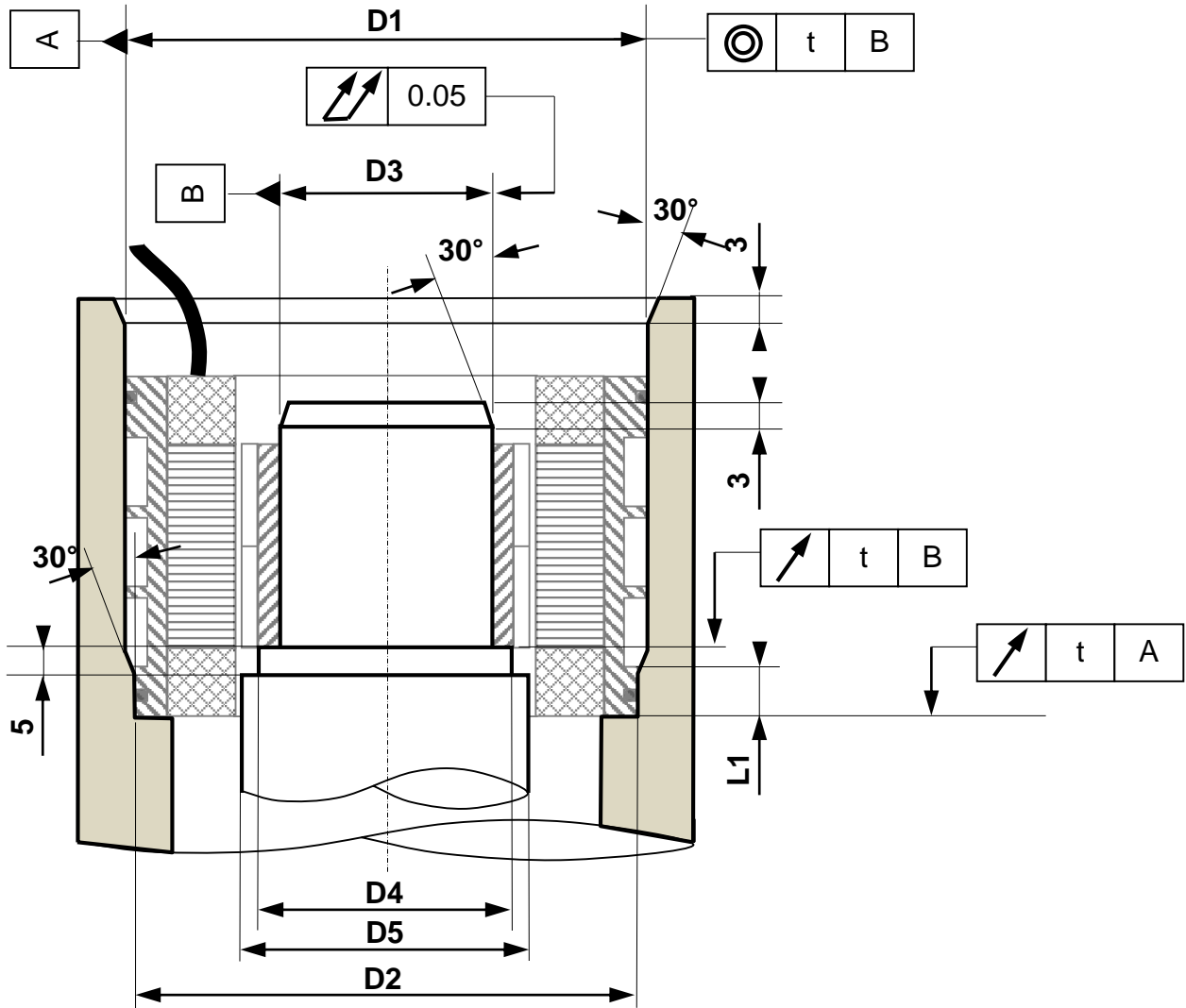

3.4.2.2. Rotor and stator block on opposite side

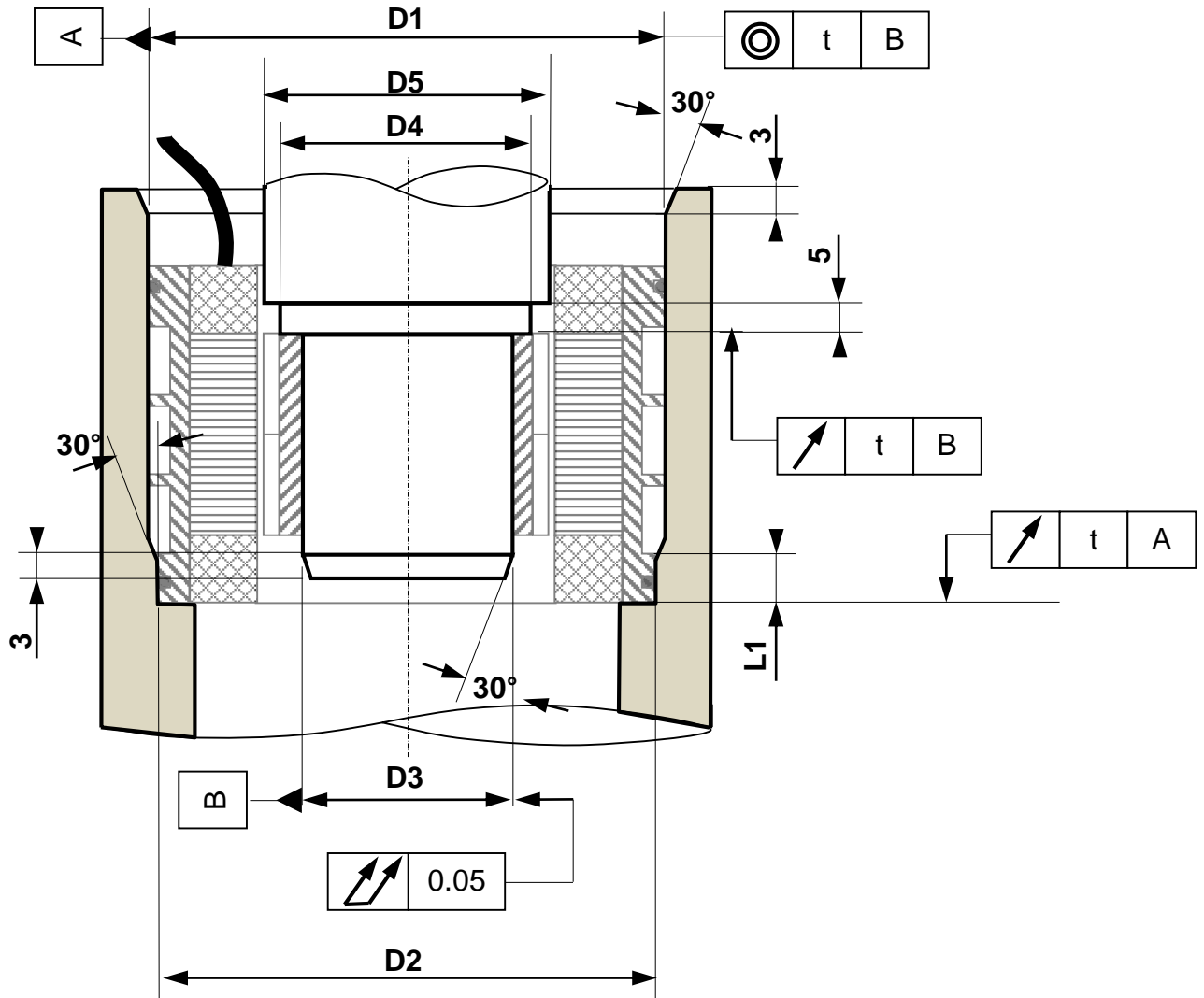

Motor	D1 (mm)	D2 (mm)	D3 (mm)	D4 (mm)	D5 (mm)	L1 (mm)	t (mm)
TKA130 and TKW130	230H8	230H8	132g7	146+/-0.2	151 max	N/A	0.10
TKA200	385H8	385H8	250g7	275+/-0,2	280 max	N/A	0,10
TKW201 to TKW204		383H8				14+/-0.2	
TKW205 to TKW208							
TKA300	565H8	565H8	420g7	457+/-0,2	462 max	N/A	0,15
TKW301 to TKW304		563H8				25+/-0.2	
TKW305 to TKW30A							
TKA400	795H8	795H8	620g7	652+/-0,2	658 max	N/A	0,20
TKW401 to TKW404		793H8				25+/-0.2	
TKW405 to TKW40C							

3.4.3. Water inlet / outlet position

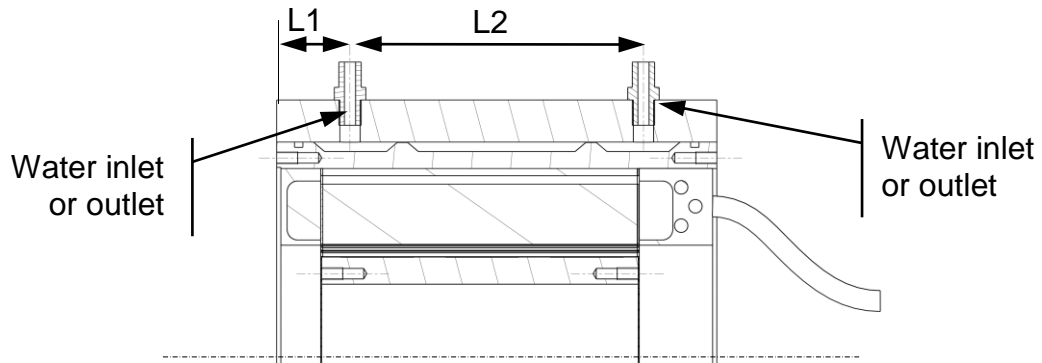

Motor version	L1 (mm)	L2 (mm)	Water inlet or outlet diameter
TKW131H	25	40	1/8"BSP
TKW132H		90	
TKW133H		140	
TKW134H		196	
TKW135H		256	
TKW136H		306	
TKW201H	35	40	1/4"BSP
TKW202H		90	
TKW203H		140	
TKW204H		200	1/2"BSP
TKW205H		270	
TKW206H		320	
TKW208H		410	
TKW301H	35	40	1/4"BSP
TKW302H		90	
TKW303H		140	
TKW304H	45	185	3/4"BSP
TKW305H		250	
TKW306H		290	
TKW308H		395	
TKW308HC		430	
TKW30AH		500	
TKW30AHD		560	
TKW401H	45	40	3/4"BSP
TKW402H		90	
TKW403H		140	
TKW404H		190	
TKW405H		260	
TKW406H		310	
TKW408H		410	
TKW40AH		515	
TKW40CH		620	

3.4.4. O ring specification

The cooling circuit is sealed by two O-rings seal between stator and user's housing.

	<p><u>Caution:</u> The 2 O-rings must be greased with an ordinary lubricant before mounting to avoid damages and leakages.</p>
--	--

	<p><u>Caution:</u> Be careful not to make damage on the O-ring during the mounting to avoid leakage. It's recommended to realize a waterproof test with 5 bars air pressure during 30 minutes and check if there is not pressure decreasing.</p>
--	--

	<p><u>Caution:</u> Water inlet and outlet must be aligned with the cables inlet to guarantee an optimized cooling circulation.</p>
--	--

Motor	O-ring diameter (mm)	Cross section (mm)	Material	Hardness	Working temperature (°C)	PARKER part number
TKW130	210	3	NBR	70 shores	-25 / +120	5340P0098
TKW200	370	3	NBR	70 shores	-25 / +120	5340P0091
TKW300	540	4	NBR	70 shores	-25 / +120	5340P0089
TKW400	760	4	NBR	70 shores	-25 / +120	5340P0090

3.4.5. Condensation water drain hole

Condensation and risk of rust may occur when the temperature gradient between the air and the water becomes significant, so drain holes must be integrated on the frame design. These holes must be positioned at the lowest point in the motor housing. Condensation water drain holes must be checked at least once a year

3.4.6. Design Compliance

The integrator is responsible for compliance with directives, regulations and standards. Nonexhaustively, the integrator has to certify the complete motor design in order to be conformed to the guide lines (nonexhaustively).

- Low Voltage Directive 2014/35/EU
- RoHs Directive 2011/65/CE
- EMC Directive 2004/108/CE

The complete motor must comply with the IEC60034 standard

The heating of the complete motor must meet the requirements of the class F insulation (cf. IEC 60034-1)

3.4.7. Dielectric test

Each complete motor must undergo once completely, a dielectric test (Routine test) in accordance with the standard IEC 60034-1 (i.e. 1500 V during 1 min for 230 Vac).

3.4.8. Earthing

A protective earth cable with the appropriate cable diameter must connect the complete motor stator to the grounding (cf. standards: NF C15-100, CEI 60364-1, IEC 60204-1).

Section of phases conductors, S [mm ²]	Corresponding minimal cross-section of earthing conductor, S_p [mm ²]
$S \leq 16$	S
$16 < S \leq 35$	16
$S > 35$	$0.5S$

3.4.9. Minimum clearances for insulation and creepage distances

Depending on the pollution degree and the voltage in use, the minimum clearances for insulation and creepage distances must meet the standard EN 60664-1.

It is the integrator's responsibility to take the needed actions to comply with these distances or by adding proper additional insulation.

For information:

- *Pollution degree 1.* No pollution or only dry, nonconductive pollution occurs. The pollution has no influence (example: sealed or potted products).
- *Pollution degree 2.* Normally only nonconductive pollution occurs. Occasionally a temporary conductivity caused by condensation must be expected (example: product used in typical office environment).
- *Pollution degree 3.* Conductive pollution occurs, or dry, nonconductive pollution occurs that becomes conductive due to expected condensation (example: products used in heavy industrial environments that are typically exposed to pollution such as dust).
- *Pollution degree 4.* Pollution generates persistent conductivity caused, for instance, by conductive dust or by rain or snow.

Minimum clearances for insulation:

Voltage rms	Required impulse withstand voltage V	Minimum clearances in air in millimeters up to 2000 m above sea level							
		Case A (inhomogeneous field)				Case B (homogeneous field)			
		Pollution degree				Pollution degree			
		1 mm	2 mm	3 mm	4 mm	1 mm	2 mm	3 mm	4 mm
50V	600	0,06	0,2	0,8	1,6	0,06	0,2	0,8	1,6
from 100V to 250V	1500	0,5	0,5	0,8	1,6	0,3	0,3	0,8	1,6
up to 500V	2000	1	1	1	1,6	0,45	0,45	8	1,6

N.B. Please refer to the standard EN 60664-1 for more information.

Minimum creepage distances for equipment subject to long-term stresses

Voltage rms	Creepage distances in millimeters									
	Pollution degree									
	1	2 Material group			3 Material group			4 Material group		
	mm	I mm	II mm	III mm	I mm	II mm	III mm	I mm	II mm	III mm
50	0,18	0,6	0,85	1,2	1,5	1,7	1,9	2	2,5	3,2
100	0,25	0,71	1	1,4	1,8	2	2,2	2,4	3	3,8
160	0,32	0,8	1,1	1,6	2	2,2	2,5	3,2	4	5
200	0,42	1	1,4	2	2,5	2,8	3,2	4	5	6,3
250	0,56	1,25	1,8	2,5	3,2	3,6	4	5	6,3	8
320	0,75	1,6	2,2	3,2	4	4,5	5	6,3	8	10
400	1	2	2,8	4	5	5,6	6,3	8	10	12,5
500	1,3	2,5	3,6	5	6,3	7	8	10	12,5	16

N.B. Please refer to the standard EN 60664-1 for more information.

3.4.10. Ground continuity compliance

The complete motors must meet the standards IEC 60204-1.

Continuity of the grounding circuit : On each complete unit, the resistance between any conductive point and the grounding conductor shall not exceed than 100 mΩ. This test shall be performed before the dielectric tests. (EN 60204-1: Safety of the machine)

3.4.11. Protection rating

cf. IEC 60529 and IEC 60034-5

The frameless motors show an IP00 protection rating. It is the integrator's responsibility to ensure the appropriate protection rating depending on the use of the complete motor (protection against electric shocks of persons, protection against dust, liquids, solid particles, ...)

3.4.12. Overspeed test

A qualification test at 20% above the rated speed during at least 1 min, must be carried out according to the standard IEC 60034-1.

3.4.13. EMC Directive

cf. guide lines 2004-108 CE and standard IEC 61800-3

It is the integrator's responsibility to ensure that the complete motor and drive in use comply with the EMC directive.

3.4.14. Other requirements

The previous list is not exhaustive and all the other requirements in the regulation standard and directives must be checked by the integrator.

3.5. Cooling

In compliance with the IEC 60034-1 standards:

3.5.1. Natural cooled motor – TKA series







The ambient air temperature shall not be lower than **-15°C** and higher than **40°C**.

	<p>Warning: To reach the motor performances calculated, the complete motor must thermally well connected to a aluminium flange with the following surface:</p>			
	TKA131	0,13 m ²	TKA301	0,37 m ²
	TKA132	0,24 m ²	TKA302	0,64 m ²
	TKA133	0,35 m ²	TKA303	0,90 m ²
	TKA134	0,46 m ²	TKA304	1,20 m ²
	TKA135	0,56 m ²	TKA305	1,40 m ²
	TKA136	0,67 m ²	TKA306	1,70 m ²
			TKA308	2,20 m ²
			TKA30A	2,80 m ²
	TKA201	0,25 m ²	TKA401	0,58 m ²
	TKA202	0,44 m ²	TKA402	0,94 m ²
	TKA203	0,63 m ²	TKA403	1,30 m ²
	TKA204	0,82 m ²	TKA404	1,70 m ²
	TKA205	1,00 m ²	TKA405	2,00 m ²
	TKA206	1,20 m ²	TKA406	2,40 m ²
	TKA208	1,60 m ²	TKA408	3,10 m ²
			TKA40A	3,80 m ²
			TKA40C	4,60 m ²

	<p>Caution: the ambient air temperature shall not exceed 40°C in the vicinity of the motor flange</p>
---	--

	<p>Warning: A significant part of the heat produced by the motor is evacuated through the flange.</p> <ul style="list-style-type: none"> • if the air is not able to circulate freely around the motor, • if the motor is mounted on a surface that dissipates not well the heating (surface with little dimensions for instance), • if the motor is thermally isolated, • if the motor is mounted on a warm surface (mounted on a gearbox for instance), <p>then the motor has to be used at a torque less than the rated torque.</p>
---	---

3.5.2. Water cooled motor – TKW series

	<p><u>Danger:</u> The cooling system has to be operational when the motor is running or energized.</p>
	<p><u>Danger:</u> The Inlet temperature and the water flow have to be monitored to avoid any exceeding temperature values.</p>
	<p><u>Caution:</u> When motor is not running, the cooling system has to be stopped 10 minutes after motor shut down.</p>
	<p><u>Caution:</u> Condensation and risk of rust may occur when the temperature gradient between the air and the water becomes significant. Condensation is also linked to hygrometry rate. To avoid any issue, we recommend: $T_{\text{water}} > T_{\text{air}} - 2^{\circ}\text{C}$. The motor can be used with an ambient temperature between 27°C to 40°C with a high water temperature but with derating. If inlet water temperature becomes higher than 25°C, derating factor must be applied according to §3.1.2 Temperature Derating</p>
	<p><u>Caution:</u> the ambient air temperature shall not exceed 40°C in the vicinity of the motor flange</p>
	<p><u>Danger:</u> If the water flow stops, the motor can be damaged or destroyed causing accidents.</p>

3.5.3. Additives for water as cooling media

Please refer to motor technical data for coolant flow rates.

The water inlet temperature must not exceed **25°C** without torque derating.

The inner pressure of the cooling liquid must not exceed **5 bars**.

	<p><u>Caution:</u> To avoid the appearance of rust on the steel of the motor cooling system, the water must have anti-corrosion additive.</p>
---	---

The torque motors are water cooled. Corrosion inhibitors must be added to the water to avoid the corrosion. The complete cooling system must be taken into account to choose the right additive, this includes: the different materials in the cooling circuit, the chiller manufacturer recommendations, the quality of the water...

The right additive solution is the responsibility of the user. Some additives like TYFOCOR or GLYSANTIN G48 correctly used have demonstrated their ability to prevent corrosion in a closed cooling circuit

For example: Glysantin G48 recommendations are :

- Water hardness: 0 to 20°dH (0 – 3.6 mmol/l)
- Chloride content: max. 100ppm
- Sulphate content: max. 100ppm

	<p><u>Caution:</u> The water quality is very important and must comply with supplier recommendations. The additive quantity and periodic replacement must respect the same supplier recommendations.</p>
---	--

	<p><u>Caution:</u> The additive choice must take into account the global cooling system (chiller or water exchanger recommendations...).</p>
---	--

	<p>Select carefully the materials of all the cooling system parts (chiller, exchanger, hoses, adapters and fittings) because the difference between material galvanic potential can make corrosion.</p>
---	---



3.5.4. Motor cooling circuit drop pressure

The tab below describes the drop pressure at the water flow rate from the motor data:

Motor type	Drop pressure @ nominal water flow
TKW131	0.05 bars
TKW132	0.06 bars
TKW133	0.06 bars
TKW134	0.08 bars
TKW135	0.11 bars
TKW136	0.11 bars
TKW201	0.10 bars
TKW202	0.11 bars
TKW203	0.11 bars
TKW204	0.15 bars
TKW205	0.15 bars
TKW206	0.15 bars
TKW208	0.20 bars
TKW301	0.14 bars
TKW302	0.20 bars
TKW303	0.20 bars
TKW304	0.25 bars
TKW305	0.25 bars
TKW306	0.25 bars
TKW308	0.35 bars
TKW30A	0.35 bars
TKW401	0.20 bars
TKW402	0.20 bars
TKW403	0.30 bars
TKW404	0.30 bars
TKW405	0.45 bars
TKW406	0.45 bars
TKW408	0.45 bars
TKW40A	0.85 bars
TKW40C	0.85 bars

3.5.5. Chiller selection

This section describes how to choose the chiller. The chiller is able to evacuate the heat from the motor losses with the water circulation.

The motor losses (= power to evacuate by the chiller) depends on the efficiency and motor power:

$$P_c = \left(\frac{1}{\rho} - 1 \right) \cdot P_n$$

With P_c : Power to evacuate by the chiller (kW)
 P_n : Nominal motor power (kW)
 ρ : motor efficiency at nominal power (%)

Refer to the respective torque motor data sheet for nominal power, efficiency and water flow.

Chiller pump must provide water flow through motor and pipe pressure drop. Inlet temperature must be inferior to **25°C**.

Example

Motor: TKW306HF

Nominal power = 113kW

Efficiency = 88.4%

Water flow = 22 l/min

$$P_c = \left(\frac{1}{0.884} - 1 \right) \cdot 113 = \mathbf{14.8 \text{ kW}}$$

So, the chiller must evacuate 14.8 kW and has a water flow of 22 l/min for a TKW306HF



3.5.6. Parker Hiross Chiller selection vs TMW series

You can find various chillers solutions in Parker Hiross - <http://www.dh-hiross.com/>

Motor Type	Power dissipation [kW]	Flow rate [l/min]	Series Hyperchill type ICE		
			Chiller	Power dissipation capability [kW]	Flowrate capability [l/min]
TKW131H	1,5	2.2 l / min	ICE003	2,0	2,2
TKW132H	2,2	3.4 l / min	ICE005	4,2	5,3
TKW133H	3,7	5.5 l / min	ICE005	4,2	5,3
TKW134H	4,5	6.8 l / min	ICE007	6,8	9,6
TKW135H	5,6	8.3 l / min	ICE007	6,8	9,6
TKW136H	6,7	10 l / min	ICE007	6,8	9,6
TKW201H	2,0	2.9 l / min	ICE003	2,0	2,2
TKW202H	4,1	5.8 l / min	ICE005	4,2	5,3
TKW203H	5,7	8 l / min	ICE007	6,8	9,6
TKW204H	7,3	10 l / min	ICE015	11,0	16,0
TKW205H	8,8	13 l / min	ICE015	11,0	16,0
TKW206H	10,3	15 l / min	ICE015	11,0	16,0
TKW208H	13,6	19 l / min	ICE022	17,9	25,5
TKW301H	3,3	4.8 l / min	ICE005	4,2	5,3
TKW302H	5,7	8.4 l / min	ICE007	6,8	9,6
TKW303H	8,0	12 l / min	ICE015	11,0	16,0
TKW304H	10,3	15 l / min	ICE015	11,0	16,0
TKW305H	12,3	18 l / min	ICE022	17,9	25,5
TKW306H	14,9	22 l / min	ICE022	17,9	25,5
TKW308H	19,5	29 l / min	ICE029	23,1	33,1
TKW30AH	23,9	36 l / min	ICE039	31,7	45,1
TKW401H	4,0	5.8 l / min	ICE005	4,2	5,3
TKW402H	7,3	11 l / min	ICE015	11,0	16,0
TKW403H	11,1	16 l / min	ICE022	17,9	25,5
TKW404H	14,2	20 l / min	ICE022	17,9	25,5
TKW406H	20,7	30 l / min	ICE029	23,1	33,1
TKW408H	26,4	39 l / min	ICE039	31,7	45,1
TKW40AH	32,7	48 l / min	ICE046	37,2	53,3
TKW40CH	39,2	58 l / min	ICE057	45,8	65,5

3.5.7. Flow derating according to glycol concentration

	Glycol concentration [%]					
	0	10	20	30	40	50
5	5.1	5.3	5.6	5.9	6.2	
10	10.2	10.6	11.1	11.8	12.4	
15	15.3	15.9	16.7	17.6	18.7	
20	20.4	21.2	22.2	23.5	24.9	
25	25.5	26.5	27.8	29.4	31.1	
30	30.6	31.8	33.4	35.3	37.3	
35	35.7	37.1	38.9	41.1	43.6	
40	40.8	42.4	44.5	47.0	49.8	
45	45.9	47.7	50.0	52.9	56.0	
50	51.0	53.0	55.6	58.8	62.2	
55	56.1	58.3	61.2	64.7	68.4	
60	61.2	63.5	66.7	70.5	74.7	
65	66.4	68.8	72.3	76.4	80.9	
70	71.5	74.1	77.8	82.3	87.1	
75	76.6	79.4	83.4	88.2	93.3	
80	81.7	84.7	89.0	94.1	99.5	
85	86.8	90.0	94.5	99.9	105.8	
90	91.9	95.3	100.1	105.8	112.0	
95	97.0	100.6	105.6	111.7	118.2	
100	102.1	105.9	111.2	117.6	124.4	
110	112.3	116.5	122.3	129.3	136.9	
120	122.5	127.1	133.4	141.1	149.3	
130	132.7	137.7	144.6	152.8	161.8	
140	142.9	148.3	155.7	164.6	174.2	
150	153.1	158.9	166.8	176.3	186.6	
160	163.3	169.5	177.9	188.1	199.1	
170	173.5	180.1	189.0	199.9	211.5	
180	183.7	190.6	200.2	211.6	224.0	
190	194.0	201.2	211.3	223.4	236.4	
200	204.2	211.8	222.4	235.1	248.9	

Use of the table above - Example

If the motor needs **25 l/min** with **0%** glycol,

If application needs **20%** glycol, the water flow must be **26.5 l/min**,

If application needs **40%** glycol, the water flow must be **29.4 l/min**.



According to the table “Parker Hiross Chiller selection vs TMW series” given
The motor needs a chiller:

- ICE022** with **0%** glycol,
- ICE029** with **20%** glycol,
- ICE029** with **40%** glycol.

<u>Glycol concentration</u>	0%	20%	40%
Flow rate requested [l/min]	25	26.5	29.4
Chiller type:	ICE022	ICE029	ICE029
Flow rate capability [l/min]	25.5	33.1	33.1

Main formulas

$$Flow_rate = \frac{Power_dissipation * 60}{\Delta\theta * C_p}$$

- With:
- Flow rate* [l/min]
 - Power_dissipation* [W]
 - $\Delta\theta$ Gradient inlet-outlet [°C]
 - C_p** thermal specific capacity of the water as coolant [J/kg°K]
(**C_p** depends on the % glycol concentration please see below)

Thermal specific capacity C_p according to % glycol concentration and temperature

We have considered an average temperature of the coolant of 30°C.

Glycol concentration [%]	Average temperature of the water as coolant [°C]	Thermal specific capacity of the water C_p [J/kg°K]
0	30	4176
30	30	3755
40	30	3551
50	30	3354

3.5.8. Water cooling diagram



Recommendation: The use of a filter allows reducing the presence of impurities or chips in the water circuit in order to prevent its obstruction. We recommend 0.1mm filter.

This section shows typical water cooling diagram :

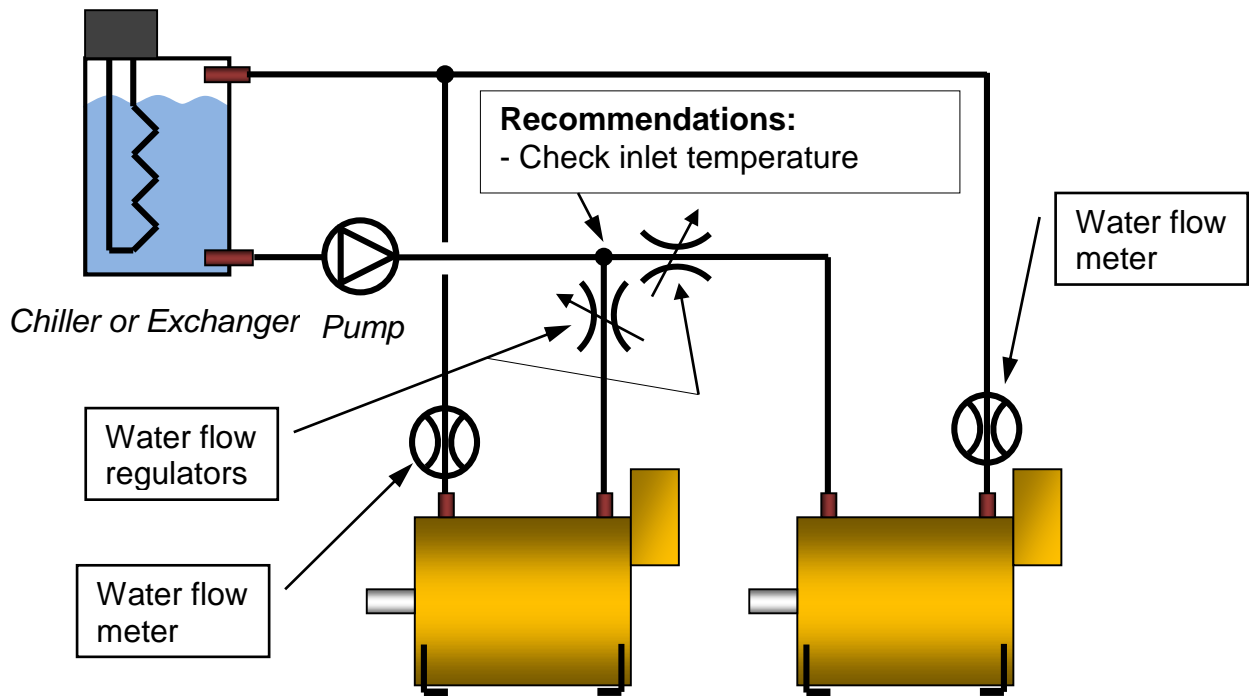
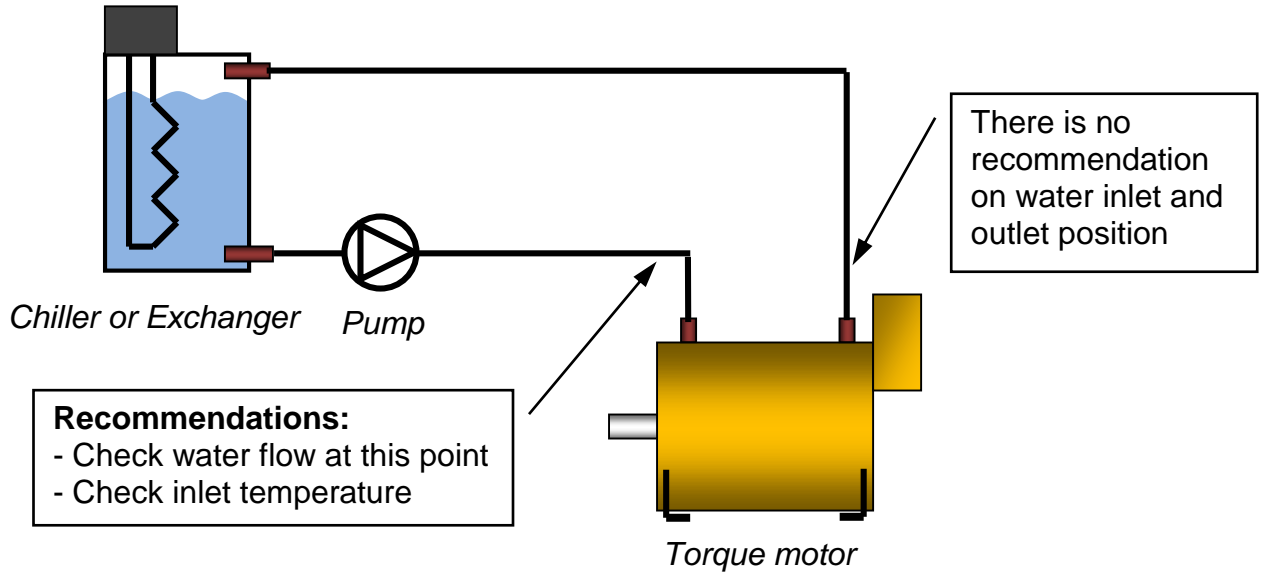

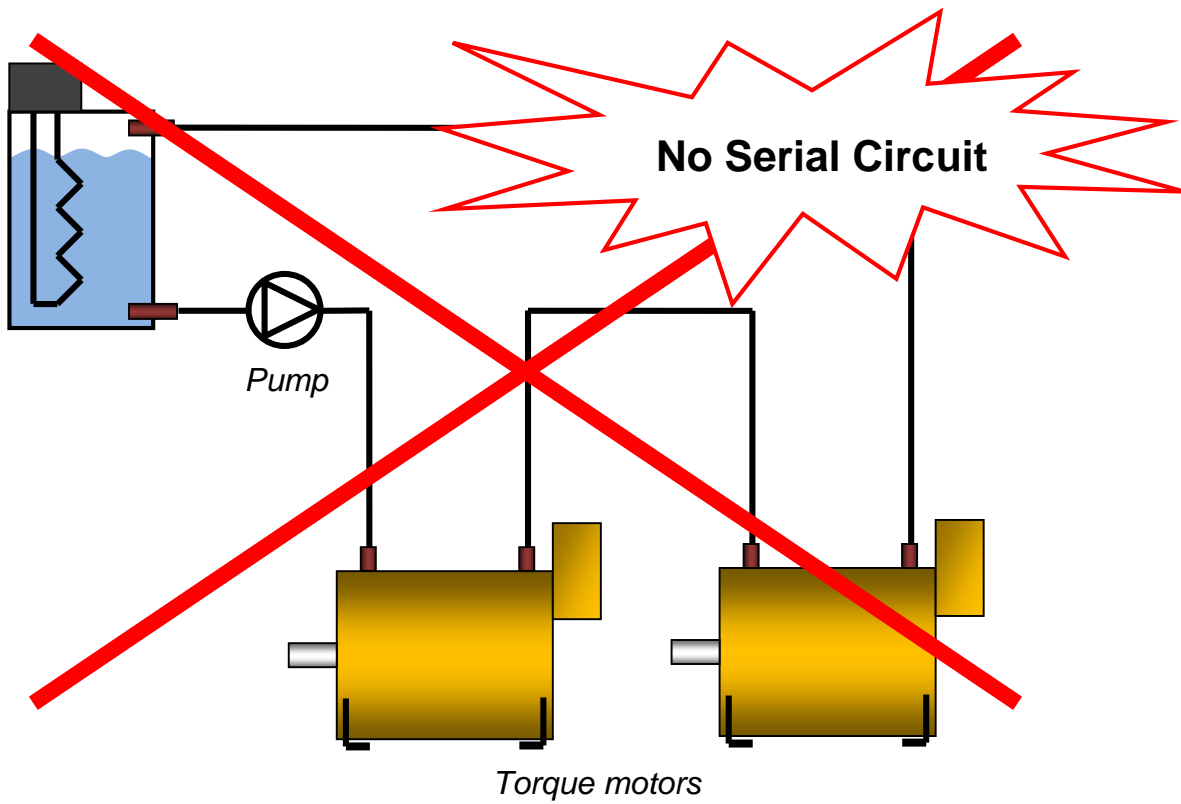
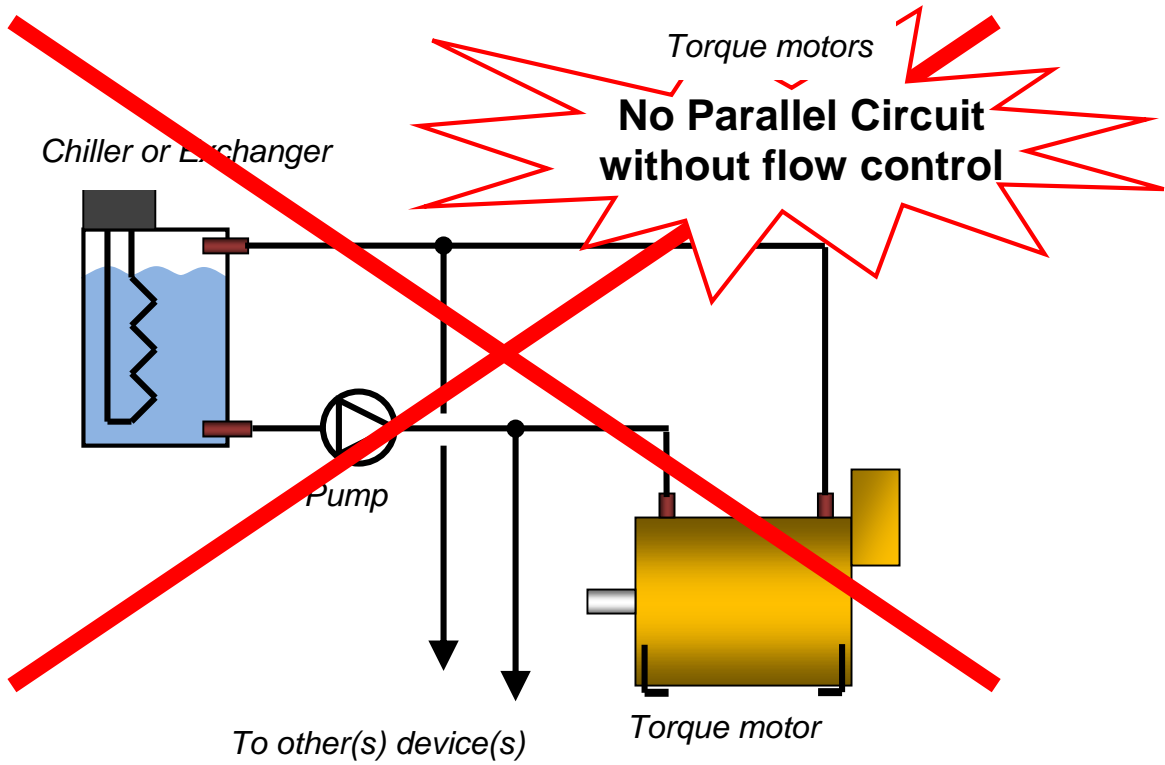



3.5.9. Condensation water drain hole

Condensation and risk of rust may occur when the temperature gradient between the air and the water becomes significant, so drain holes must be integrated on the frame design. These holes must be positioned at the lowest point in the motor housing. Condensation water drain holes must be checked at least once a year

3.6. Thermal Protection

Protection against thermal overloading of the motor is provided by 2 x 3 PTC thermistors and one KTY temperature sensor (and one more in case of KTY failure) built into the stator winding as standard. The thermal sensors, due to their thermal inertia, are unable to follow very fast winding temperature variations. They achieve their thermal steady state after a few minutes.

	<p>Warning: To protect correctly the motor against very fast overload, please refer to 3.1.6. Peak current limitations</p>
--	---

All thermal protection wires section is AWG26.

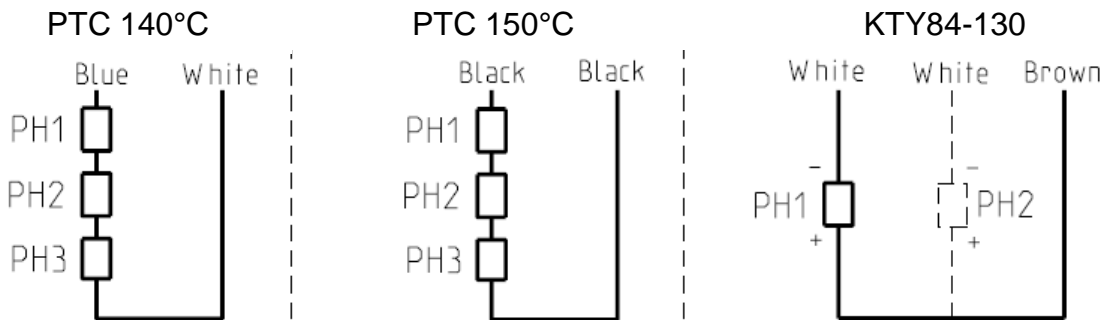

3.6.1. Alarm tripping with PTC thermistors :

Two thermal probes (PTC thermistors) fitted in the servomotor winding trip the electronic system at **140° and 150° ± 5° C**. When the rated tripping temperature is reached, the PTC thermistor undergoes a step change in resistance. This means that a limit can be easily and reliably detected by the drive.

The graph and tab below shows PTC sensor resistance as a function of temperature (T_N is nominal temperature)

Temperature	Resistance value
-20°C up to $T_N - 20^\circ\text{C}$	$R \leq 750\Omega$
$T_N - 5^\circ\text{C}$	$R \leq 1650\Omega$
$T_N + 5^\circ\text{C}$	$R \geq 3990\Omega$
$T_N + 15^\circ\text{C}$	$R \geq 12000\Omega$

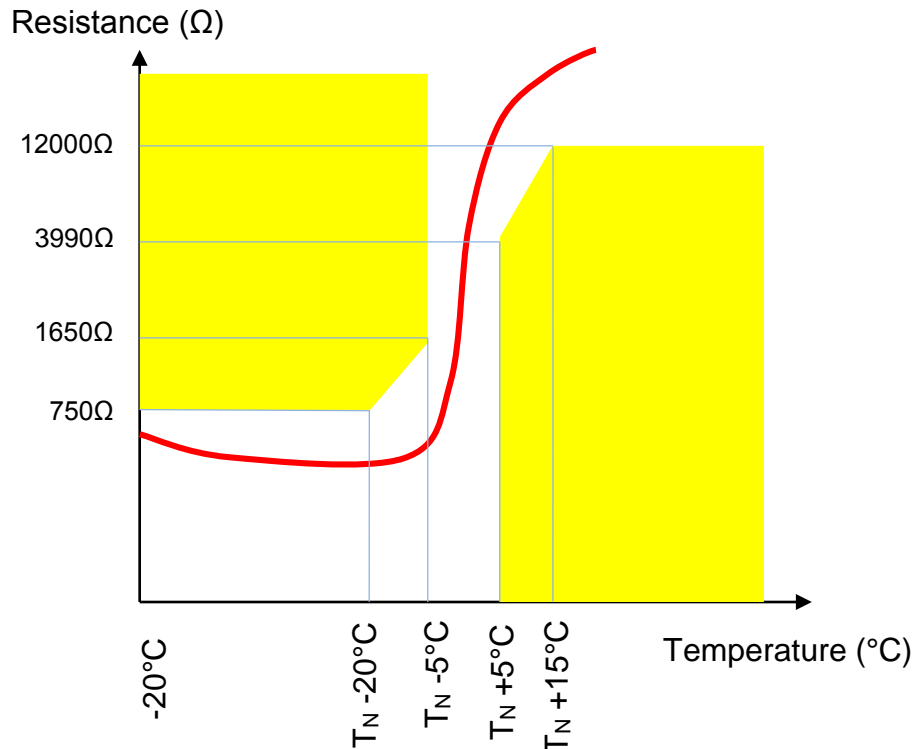

3.6.2. Temperature measurement with KTY sensors:

Motor temperature can also be continuously monitored by the drive using a KTY 84-130 thermal sensor built in to the stator winding. KTY sensors are semiconductor sensors that change their resistance according to an approximately linear characteristic. The required temperature limits for alarm and tripping can be set in the drive.

The graph below shows KTY sensor resistance vs temperature, for a measuring current of 2 mA:

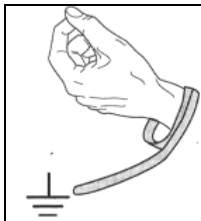
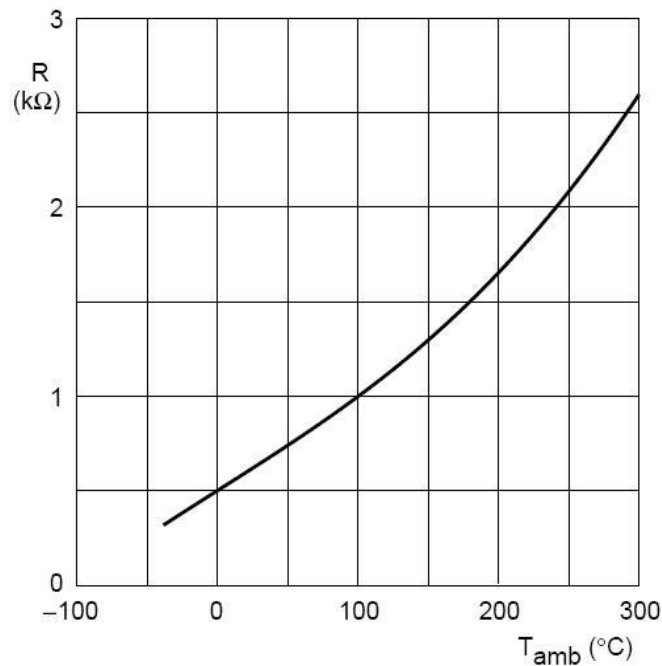

Warning: KTY sensor is sensitive to electrostatic discharge. So, always wear an antistatic wrist strap during KTY handling.



Warning: KTY sensor is polarized. Do not invert the wires.



Warning: KTY sensor is sensitive. Do not check it with an Ohmmeter or any measuring or testing device.

3.7. Power Electrical Connections

3.7.1. Wires sizes

	<p>In every country, you must respect all the local electrical installation regulations and standards.</p>
---	--

Not limiting example in France: NFC 15-100 or IEC 60364 as well in Europe.

	<p>Cable selection depends on the cable construction, so refer to the cable technical documentation to choose wire sizes</p>
---	--

	<p>Some drives have cable limitations or recommendations; please refer to the drive technical documentation for any further information.</p>
--	--

Cable selection

	<p>At standstill, the current must be limited at 80% of the low speed current I_0 and cable has to support peak current for a long period. So, if the motor works at standstill, the current to select wire size is $\sqrt{2} \times 0.8 I_0 \cong 1,13 \times I_0$.</p>
---	--

Sizes for H07 RN-F cable, for a 3 cores in a cable tray at 30°C max

Section [mm ²]	I _{max} [A _{rms}]
1.5	17
2.5	23
4	31
6	42
10	55
16	74
25	97
35	120
50	146
70	185
95	224
120	260
150	299
185	341
240	401
300	461



Example of sizes for H07 RN-F cable :

Conditions of use:

Case of 3 conductors type H07 RN-F: **60°C maximum**

Ambient temperature: 30°C

Cable runs on dedicated cables ways

Current limited to 80%*I₀ at low speed or at motor stall.

Example:

I₀=100 Arms

Permanent current at standstill : 80 Arms

Max permanent current in the cable = 113 Arms

Cable section selection = 35mm² for a 3 cores in a cable tray at 30°C max.

You also have to respect the Drive commissioning manual and the cables current densities or voltage specifications

3.7.2. Conversion Awg/kcmil/mm²:

Awg	kcmil	mm ²
	500	253
	400	203
	350	177
	300	152
	250	127
0000 (4/0)	212	107
000 (3/0)	168	85
00 (2/0)	133	67.4
0 (1/0)	106	53.5
1	83.7	42.4
2	66.4	33.6
3	52.6	26.7
4	41.7	21.2
5	33.1	16.8
6	26.3	13.3
7	20.8	10.5
8	16.5	8.37
9	13.1	6.63
10	10.4	5.26
11	8.23	4.17
12	6.53	3.31
14	4.10	2.08
16	2.58	1.31
18	1.62	0.82
20	1.03	0.52
22	0.63	0.32
24	0.39	0.20
26	0.26	0.13

3.7.3. Motor cable length

For motors windings which present low inductance values or low resistance values, the own cable inductance, respectively own resistance, in case of large cable length can greatly reduce the maximum speed of the motor. Please contact PARKER for further information.



Caution: It might be necessary to fit a filter at the servo-drive output if the length of the cable exceeds 25 m. Consult us.

3.7.4. Ground connection



DANGER: For the safety, you need to connect stator to the ground. Consult local regulation to choose the cross section and to know resistance limits to check ground continuity between frame and ground wire.

3.7.5. Motor cable

The motor cables are flexible, so cables can take any direction. Please refer to the outline drawing to know bending radius.



The electrical connection on torque motor in kit version is realized by high performance cable. The motor cable section depends of the motor current level. Please refer to the outline drawing to know the cross section (depending of torque/speed characteristics letter code).



Caution: The motor cables are designed for high current density, so cable surface can reach temperatures exceeding 100°C.



Caution: The wiring must comply with the drive commissioning manual and with recommended cables.

Caution: Section motor cable is lower than commissioning section cable between motor and drive due to high performance motor cable design. Do not take the same cable section than motor ones.



Attention: Do not mix feedback wires with motor wires to avoid EMI (electromagnetic interference). EMI risk to set default the drive. So, careful to separate resolver and motor wires.

4. COMMISSIONING AND USE

4.1. Instructions for commissioning and use

4.1.1. Equipment delivery

All torque motors undergo a thorough quality control procedure before shipping. Check the condition of the servomotor when carefully removing it from its packaging. Check that the information on the identification plate corresponds to your order. The package includes required document and accessories.



Caution: If the equipment has been damaged during transit, the recipient should **immediately** complain to the carrier by registered letter within 24 hours.

4.1.2. Handling

Torque Motors are equipped with three thread hole for lifting rings for handling.



Caution: Do not handle the motor with the help of electrical cables or use any other inappropriate method. Use non-magnetic material to handle rotor.

The drawings below show the correct handling procedure.

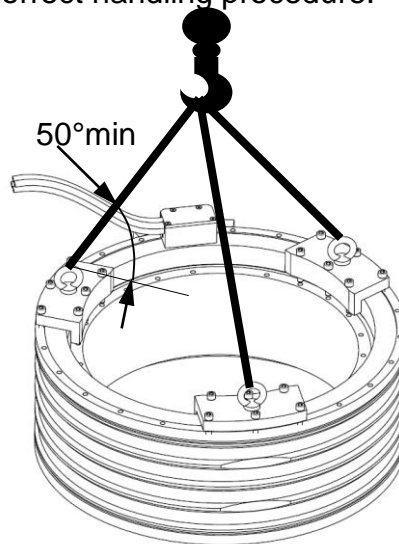

Caution: All slings should have the same length and a minimum angle of 50° between the slings and the motor axis has to be observed.

4.1.3. Storage





Before being mounted, the torque motor has to be stored in a dry place, without rapid or important temperature variations in order to avoid condensation.

During storage, the ambient temperature must be kept between -20 and +60°C.

If the torque motor has to be stored for a long time, verify that the surfaces are coated with corrosion proof product.

4.2. Machine Integration

4.2.1. General warnings

	<p><u>Caution:</u> The integrator bears the entire responsibility for the preparation of the machine design.</p>
	<p><u>Danger :</u> The integrator must certify the motor by an approved organism to comply with all the regulations (CE, ...) and perform all the mandatory routine tests (exemples : IEC60034...)</p>
	<p><u>Attention:</u> Rotor has strong permanent magnets. It creates strong attraction force that can crush fingers or hands. Firmly hold the rotor and move away all magnetic parts. <u>Caution:</u> Clean the working area of all ferromagnetic part such as tools, screws, steel particles. Use wood table to work or make machine assembly.</p>
	<p><u>Caution:</u> Anyone wearing pacemaker, hearing aid, watches, magnetic data storage device must keep at 1 meter from kit motor.</p>
	<p><u>Caution:</u> Before mounting the motor, the surface must be cleaned.</p>

4.2.2. Tightening torque

The table below gives the average tightening torques required regarding the fixing screw diameter. These values are valid for both motor's stator and rotor bolting.

Screw diameter	Tightening torque
M2 x 0.35	0.35 N.m
M2.5 x 0.4	0.6 N.m
M3 x 0.5	1.1 N.m
M3.5 x 0.6	1.7 N.m
M4 x 0.7	2.5 N.m
M5 x 0.8	5 N.m
M6 x 1	8.5 N.m
M7 x 1	14 N.m
M8 x 1.25	20 N.m

Screw diameter	Tightening torque
M9 x 1.25	31 N.m
M10 x 1.5	40 N.m
M11 x 1.5	56 N.m
M12 x 1.75	70 N.m
M14 x 2	111 N.m
M16 x 2	167 N.m
M18 x 2.5	228 N.m
M20 x 2.5	329 N.m
M22 x 2.5	437 N.m
M24 x 3	564 N.m



Warning: After 15 days, check all tightening torques on all screw and nuts.

4.2.3. Magnetic attraction forces

The axial attraction force (F_a) during the rotor insertion in the stator is:

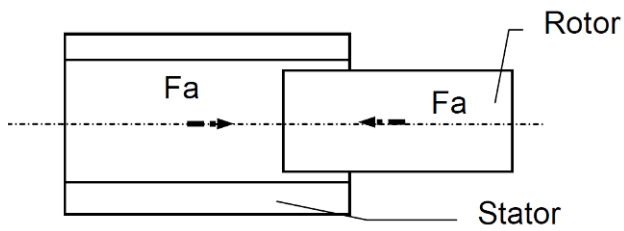

Motor	Axial attraction force (N)
TKW130	237
TKW200	406
TKW300	780
TKW400	1111

The radial attraction force is proportional to the rotor eccentricity x :

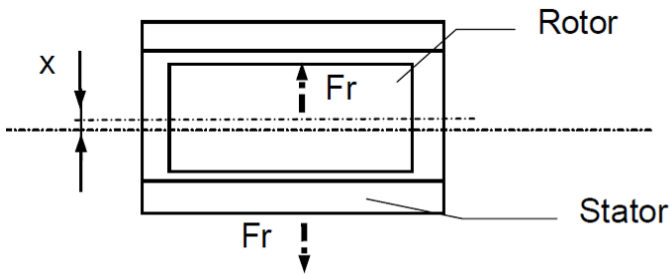

Motor	Radial attraction force F_r at the maximum rotor eccentricity (N)
TKW131	550
TKW132	1100
TKW133	1650
TKW134	2200
TKW135	2750
TKW136	3300
TKW201	1050
TKW202	2100
TKW203	3150
TKW204	4200
TKW205	5250
TKW206	6300
TKW208	8400

Motor	Radial attraction force F_r at the maximum rotor eccentricity (N)
TKW301	1700
TKW302	3400
TKW303	5100
TKW304	6800
TKW305	8500
TKW306	10200
TKW308	13600
TKW30A	17000
TKW401	2000
TKW402	4000
TKW403	6000
TKW404	8000
TKW405	10000
TKW406	12000
TKW408	16000
TKW40A	20000
TKW40C	24000

4.2.4. Integration step by step

The following procedure describes step by step the motor integration in the machine. Different solutions exist, one is described below, and other variants are possible. Due to the magnetic part and the **risk to glue the rotor on the stator**, the main idea is to fit rotor or stator on machine before to remove bridge and finish by assembly the motor part remaining on the machine.

Machine overview

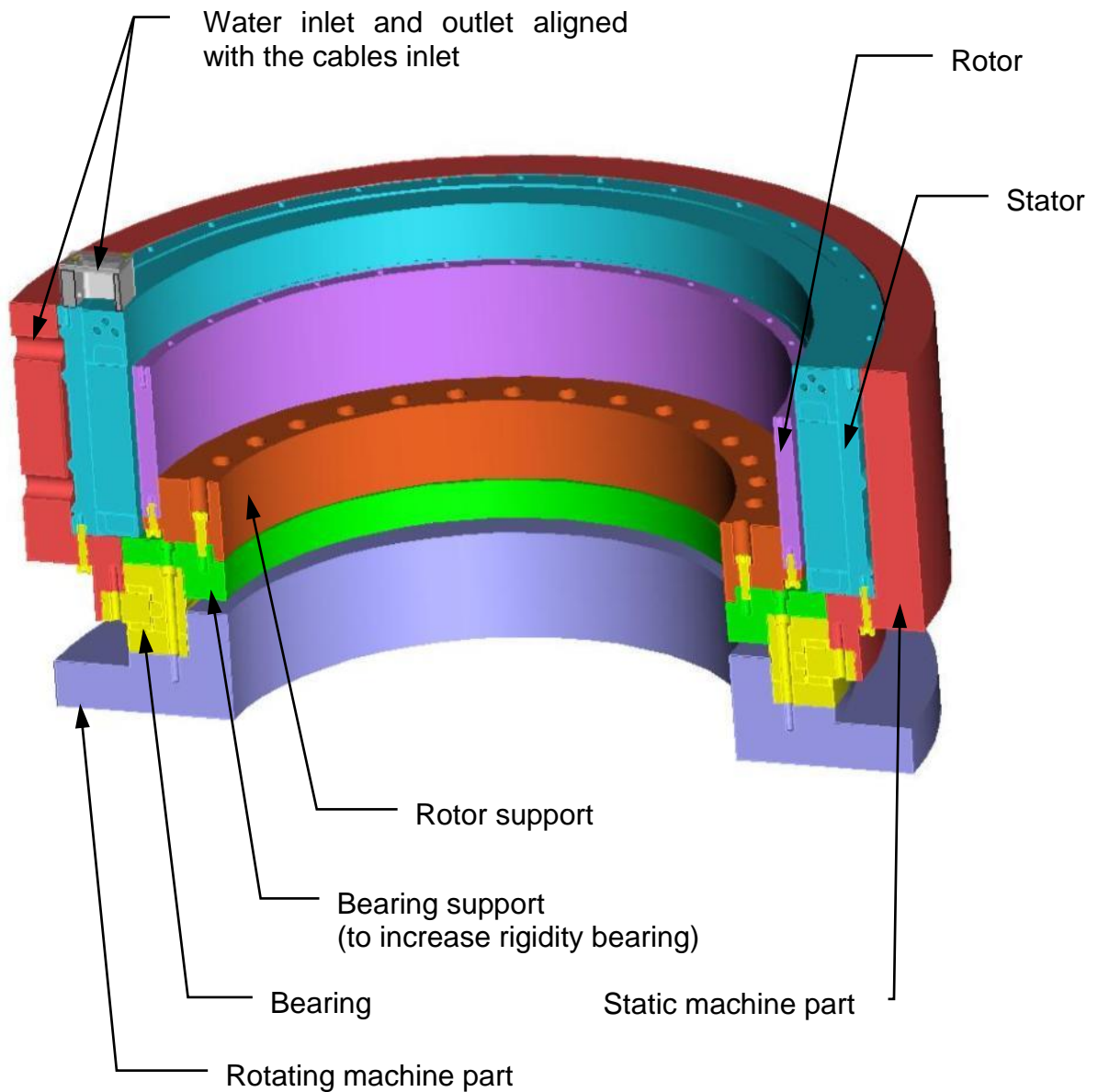

Step 1 : Machine Preparation

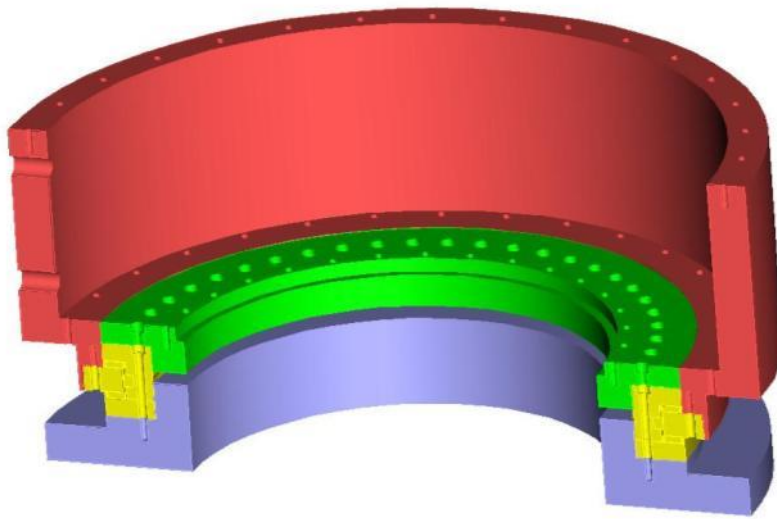

Assemble main mechanical parts (static housing, bearing support and rotating part) around bearing

Step 2 : Motor Preparation

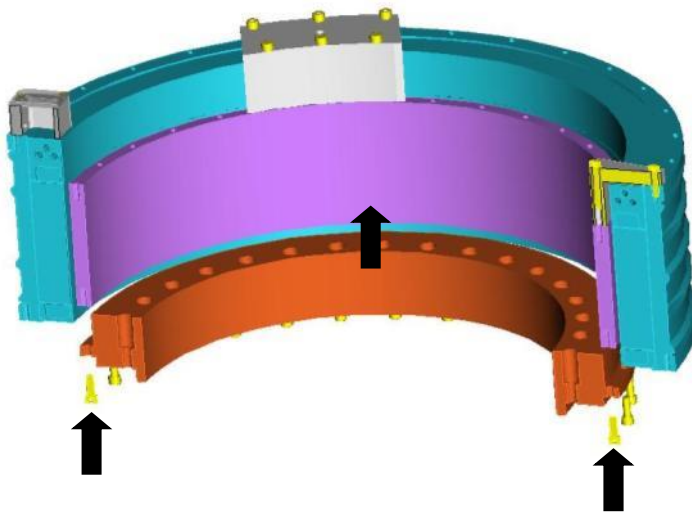

Assemble rotor support on rotor

Step 3 : Motor Positioning

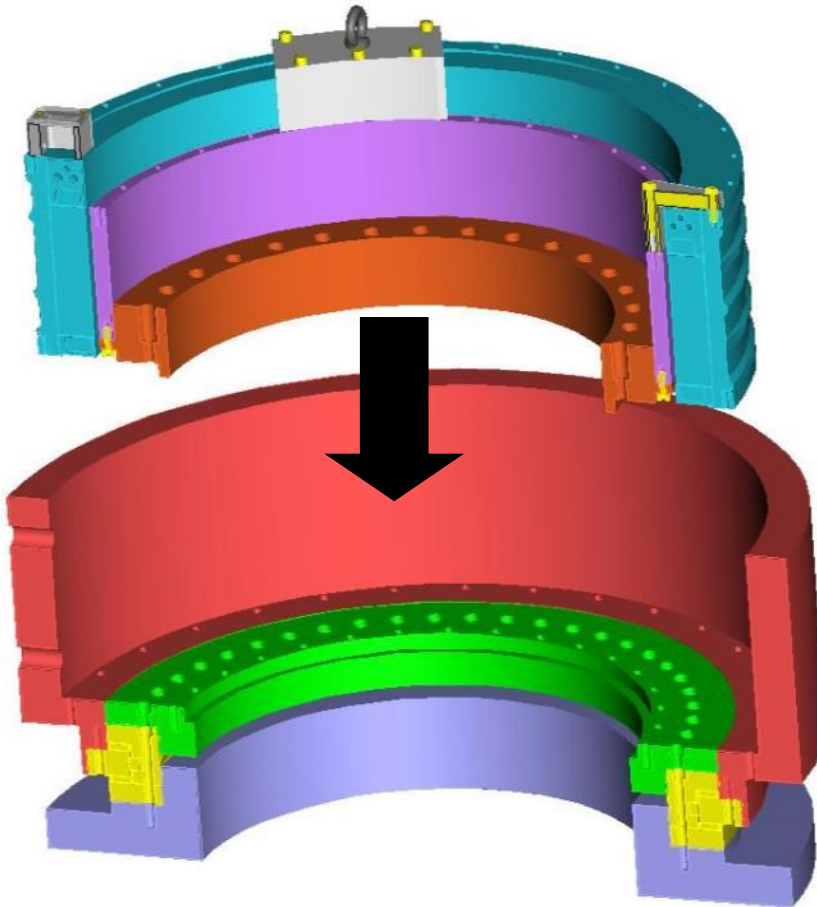

Push down the motor on the machine

The 2 O-rings must be greased with an ordinary lubricant before mounting to avoid damages and leakages

Water inlet and outlet must be aligned with the cables inlet



Caution: Be careful not to make damage on the O-ring during the mounting to avoid leakage. After last mounting step, it's recommended to realize a waterproof test with 5 bars air pressure during 30 minutes and check if there is not pressure decreasing.

Step 4 : Motor fixation

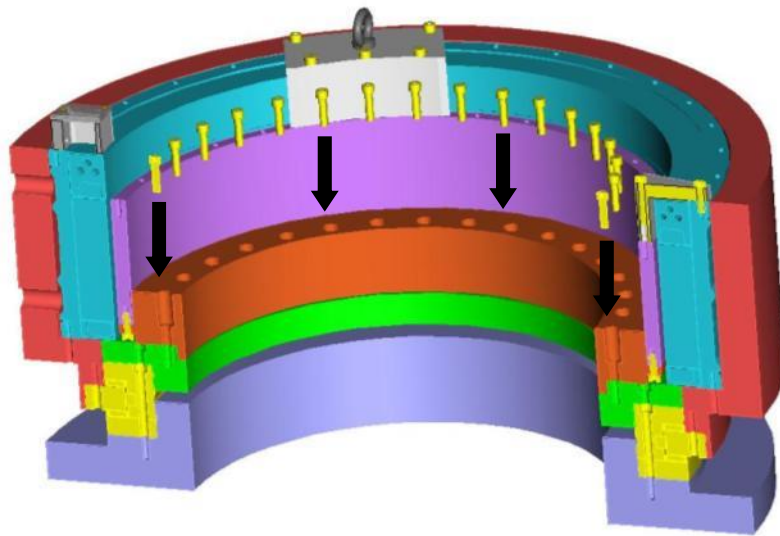

Screw rotor support on machine

Step 5 : Bridges disassembly

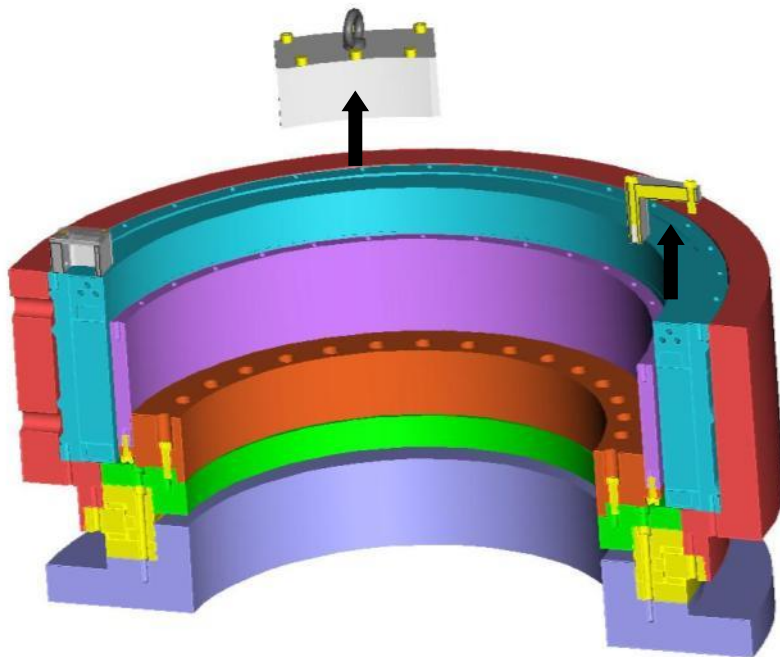

Unscrew and remove bridges

Step 6 : Stator fixation

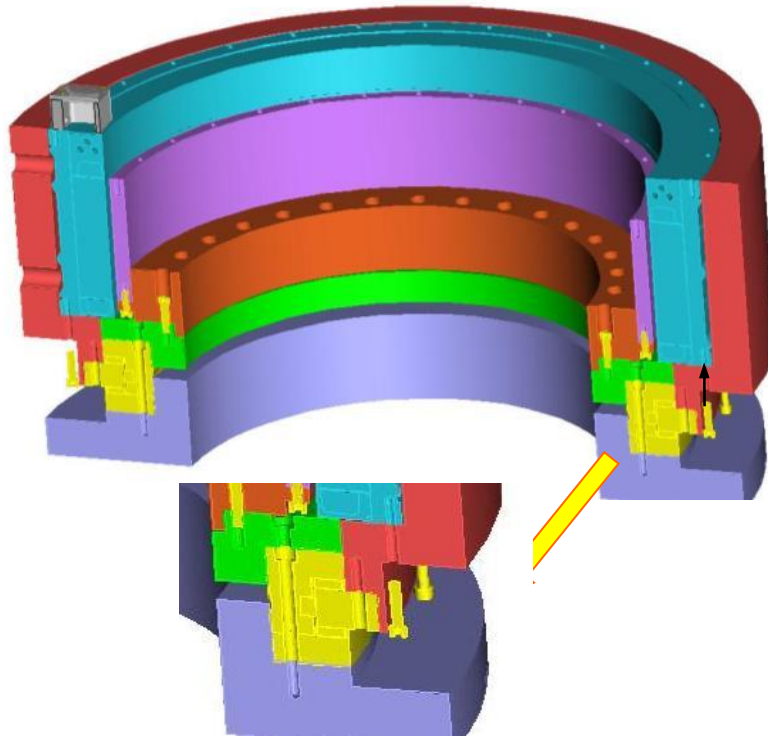

Screw stator on machine housing





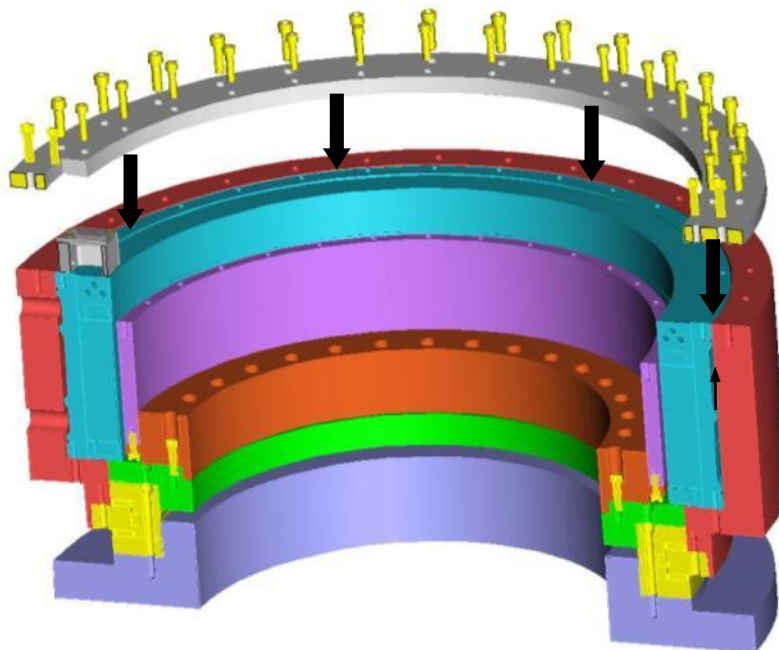

2 solutions are described below :

- either screw stator by the side opposite of the cable



- Or, screw stator by the cable side with an extra part.

4.3. Electrical connections

	<p><u>Danger:</u> Do not connect the kit to any electric supply . Only the motor can be connected to an electric supply.</p>
	<p><u>Caution:</u> Check that the power to the electrical cabinet is off prior to making any connections.</p>
	<p><u>Caution:</u> The wiring must comply with the drive commissioning manual and with recommended cables. <u>Caution:</u> Section motor cable is lower than commissioning section cable between motor and drive due to high performance motor cable design. Do not take the same cable section than motor.</p>
	<p><u>Caution:</u> The torque motor must be earthed by connecting to an unpainted section of the motor.</p>
	<p><u>Caution:</u> The motor cables are designed for high current density, so cable surface can reach temperatures exceeding 100°C.</p>
	<p><u>Warning:</u> After 15 days, check all tightening torques on all screw and nuts.</p>

Please, read §3.7 "**Electrical connection**" to have information about cable
 Many useful information is already available in the drive documentations.

The motor must be connected to the servo amplifier according to the drive user manual.
 The color code given in the table must be followed :

Black	U	V1	Phase 1
White	V	V2	Phase 2
Red	W	V3	Phase 3



The motor is shipped without a ground cable. It is mandatory to connect a (green-yellow) ground cable between the torque motor frame and machine. The ground cable cross-section must be the same as the power cable cross-section

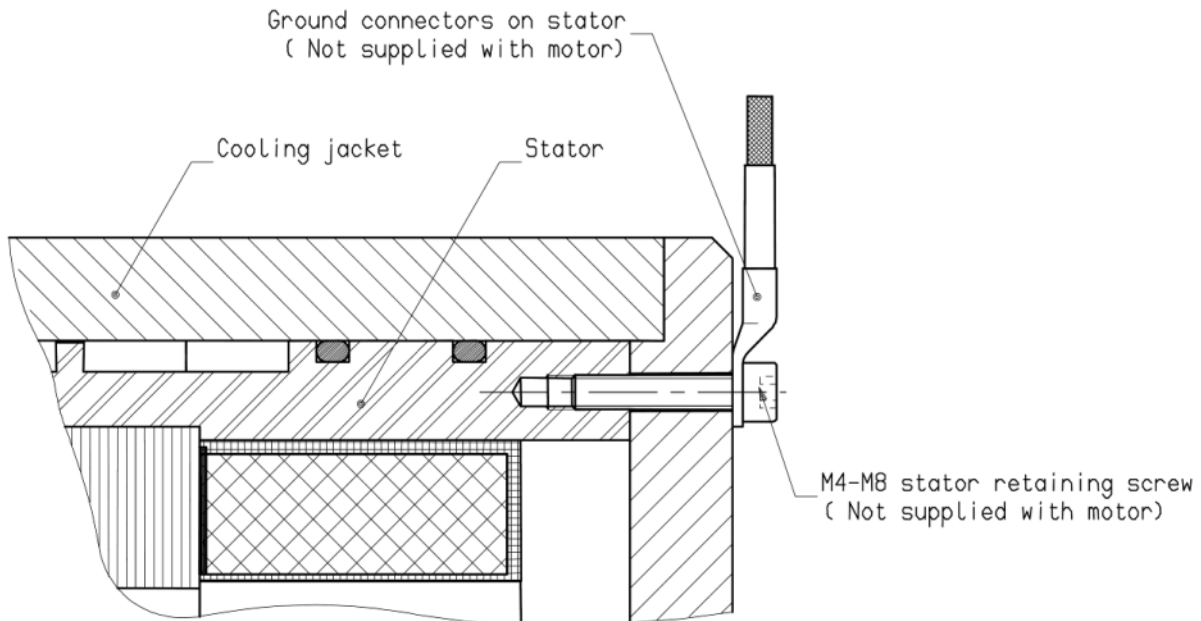

Before applying power:

- ✓ Check there is no damage on winding or cable due the mounting by a dielectric test
- ✓ Check all external wiring circuits of the system – power, control, motor and earth connections.
- ✓ Ensure that nobody is working on another part of the system who will be affected by powering up
- ✓ Ensure that other equipment will not be adversely affected by powering up.

4.4. Encoder cable handling



Danger: before any intervention the drive must be stopped in accordance with the procedure.



Caution: It is forbidden to disconnect the Encoder cable under voltage (high risk of damage and sensor destruction).



Attention: Do not mix feedback wires with motor wires to avoid EMI (electromagnetic interference). EMI risk to set default the drive. So, careful to separate resolver and motor wires.



Warning: Always wear an antistatic wrist strap during encoder handling.

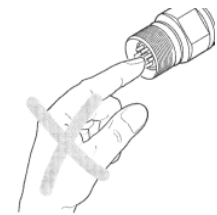

Warning: Do not touch encoder contacts (risk of damage due to electrostatic discharges ESD).

4.5. Tests

The motor components delivered by Parker are tested :

- dielectric test,
- surge test,
- winding resistance and inductance,
- direction of rotation,
- rotor flux.

But complete motor must be tested for safety reason and to comply with the regulations (CE,...).

	<p>Danger : The integrator must certify the motor by an approved organism to comply with all the regulations (CE, ...) and perform all the mandatory routine tests (exemples : IEC60034...).</p> <p>The typical process is the qualification of a complete unit and routine tests (including safety tests) on each unit produced</p>
---	---

Exemple of a summary of the recommended safety tests, to be validated bu an approved organism.

Attention : other could be needed in accordance with regulations:

- **The continuity of the grounding circuit :**

On **each** complete unit, the resistance between any conductive point and the grounding conductor shall not exceed than 100mΩ. This test shall be performed before the dielectric tests. (EN60204-1: Safety of the machine)

- **Below exemples of dielectric tests performed on each complete unit (Sefelec SMG50 can be used) for a 400V supply :**

Dielectric Test	Motor U,V,W wires	Thermal sensor wires	Brake wires	Resolver wires	Frame	Test duration, depends on power
Motor	1800V for 400 V	Connected on Frame	Connected on Frame	Connected on Frame	0V	1min
Thermal sensor	Connected on Frame	1800V for 400 V	Connected on Frame	Connected on Frame	0V	1min
Encoder	Check with encoder supplier for tests to be done					
...	...					

4.6. Troubleshooting

Some symptoms and their possible causes are listed below. This list is not comprehensive. Whenever an operating incident occurs, consult the relevant servo drive installation instructions (the troubleshooting display indications will help you in your investigation) or contact us at: <http://www.parker.com/eme/repairservice>.

<p>You note that the motor does not turn by hand when the motor is not connected to the drive.</p>	<ul style="list-style-type: none"> • Check there is no mechanical blockage or if the motor terminals are not short-circuited.
<p>You have difficulty starting the motor or making it run</p>	<ul style="list-style-type: none"> • Check on the fuses, the voltage at the terminals (there could be an overload or the bearings could be jammed), also checks on the load current. • Check the power supply to the brake (+ 24 V ± 10 %) and its polarity. • Check on any thermal protection, its connection and how it is set in the drive. • Check on the servomotor insulation (if in doubt, carry out hot and cold measurements). <p>The minimum insulation resistance value measured under a max. 50V DC is 50 MΩ:</p> <ul style="list-style-type: none"> • Between the phase and the casing • Between the thermal protection and the casing • Between the brake coil and the casing <ul style="list-style-type: none"> - Between the resolver coils and the casing.
<p>You find that the motor speed is drifting</p>	<ul style="list-style-type: none"> • Reset the offset of the servoamplifier after having given a zero instruction to the speed setpoint input.
<p>You notice that the motor is racing</p>	<ul style="list-style-type: none"> • Check the speed set-point of the servo drive. • Check you are well and truly in speed regulation (and not in torque regulation). • Check the encoder setting • Check on the servomotor phase order: U, V, W
<p>You notice vibrations</p>	<ul style="list-style-type: none"> • Check the encoder and tachometer connections, the earth connections (carefully) and the earthing of the earth wire, the setting of the servo drive speed loop, tachometer screening and filtering. • Check the stability of the secondary voltages. • Check the rigidity of the frame and motor support.
<p>You think the motor is becoming unusually hot</p>	<ul style="list-style-type: none"> • It may be overloaded or the rotation speed is too low : check the current and the operating cycle of the torque motor • Check if the mounting surface is enough or if this surface is not a heat source – see §3.5 cooling. • Friction in the machine may be too high : <ul style="list-style-type: none"> - Test the motor current with and without a load. - Check the motor does not have thermal insulation.

You find that the motor is too noisy	Several possible explanations : <ul style="list-style-type: none">• Unsatisfactory mechanical balancing• There is friction from the brake: mechanical jamming.• Defective coupling• Loosening of several pieces• Poor adjustment of servo drive or position loop : check rotation in open loop
The motor is warmer on its top	Air bubbles can be stocked in the water cooling circuit. You need to purge the circuit or to double the water flow rate during 10 minutes to remove the air bubbles.